

ZR30

4K AI 180X HYBRID ZOOM OPTICAL POD USER MANUAL



V1.2

June 2023

Thank you for purchasing SIYI's product.

ZR30 is a zoom optical pod with quick release structure and up to 180X hybrid zoom / 30X optical zoom, carrying a 4K 1/2.7-inch Sony CMOS, powerful AI identify, and tracking based on neural network processing unit, 4K video recording and photography, abundant gimbal control interface compatible with both SIYI links and third-party links. High accuracy and high collaboration control algorithms ensure stable imaging and zooming ability during flight. HDR and starlight night vision extend the application scenarios to both day and night. In a word, ZR30 optical pod is a rare and good payload for multi-rotors, VTOLs, and robotics.

To ensure you a good experience of the product, please read this manual carefully. If you encounter any issue using the product, please consult the manual or check the online pages of this product on SIYI official store (<https://shop.siyi.biz>). You can also write an email to SIYI official A/S center (support@siyi.biz).

SIYI User Group - Facebook



SIYI Official Store (<https://shop.siyi.biz>)

SIYI Official AliExpress Store (<https://siyi.aliexpress.com>)

SIYI YouTube Channel (<https://www.youtube.com/c/SIYITech>)

CONTENT

READ TIPS 1

 Icons 1

 Safety 1

 Storage / Carrying / Recycling 2

1 INTRODUCTION 3

 1.1 Product Features 3

 1.2 Parts 7

 1.2.1 At a Glance 7

 1.2.2 Pinouts 10

 1.3 Technical Specification 11

 1.4 Packing List 13

 1.5 Indicator Definition 14

2 GET READY TO USE ZR30 15

 2.1 Installation 15

 2.2 Connection and Power 16

3 GIMBAL CONTROL 17

 3.1 Control Gimbal Camera from SIYI FPV App or SIYI QGC App on SIYI Handheld Ground Station 17

 3.1.1 Preparation 17

 3.1.2 Gimbal Pitch and Yaw Rotation 19

 3.1.3 Zoom and Focus 19

 3.1.4 Take pictures and Record Video 20

 3.2 Control Gimbal through S.Bus Signal (Taking an example of MK15 remote controller) 20

 3.2.1 Preparation 21

 3.2.2 Gimbal Pitch and Yaw Rotation (Taking an example of MK15 Dials) 23

 3.2.3 Zoom and Focus (Taking an example of MK15 Switches) 24

 3.2.4 Take Pictures and Record Video (Taking an Example of MK15 Buttons) 25

 3.3 UART / UDP Control (through SDK) 26

 3.3.1 SDK Protocol Format 26

 3.3.2 SDK Communication Commands 26

 3.3.3 SIYI Gimbal Camera SDK Communication Interface 36

 3.3.4 SIYI Gimbal Camera SDK Communication Code Examples 36

3.3.5 SDK CRC16 Code	38
3.3.6 Advanced Guide for SIYI Gimbal SDK Integration	39
3.4 Control SIYI Gimbal Camera in SIYI QGC Windows Software through HM30 Image Transmission System	43
3.4.1 Preparation	43
3.4.2 Gimbal Pitch and Yaw Rotation	45
3.4.3 Zoom and Focus	46
3.4.4 Take pictures and Record Video	46
3.5 Control SIYI Gimbal Camera by the Ardupilot Driver through UART	47
4 VIDEO OUTPUT	50
4.1 Output and Display Video on SIYI Handheld Ground Station	50
4.2 Output Video Stream to Android Device through HM30 Full HD Image Transmission System	50
4.3 Output Video Stream to Windows Device through HM30 Full HD Image Transmission System	52
4.4 Output Video to Windows Device Directly	53
4.5 Output Video to Third-Party Link	55
4.6 Output by HDMI	56
4.7 Solutions to No Image	56
4.7.1 Video Output to Android Device	57
4.7.2 Video Output to Windows Device	59
4.8 Common IP Addresses	60
5 SIYI FPV APP	61
5.1 Settings	63
5.2 Link Status	64
5.3 Gimbal Camera	65
5.4 About SIYI FPV	66
6 Firmware Upgrade and Configuration	67
6.1 Gimbal / Zoom Firmware Update	68
6.2 Camera Firmware Update	71
6.3 Gimbal Camera Configuration	73
6.3.1 Channel Configuration	73
6.3.2 Camera Configuration	75
6.3.3 Gimbal Calibration	75

7 After-sale Service	80
7.1 Repair Service	80
7.2 Warranty	81
7.2.1 7-Day Return & Refund	81
7.2.2 15-Day Replacement	82
7.2.3 1-Year Warranty Repair	84

READ TIPS

Icons

Please pay more attention to content indicated with the following marks:

 **DANGER** Dangerous manipulation probably leads to human injuries.

 **WARNING** Warnings on manipulation possibly leads to human injuries.

 **CAUTION** Cautions on what manipulation may lead to property loss.

 **Prohibited**  **Mandatory**  **Mark**

Safety

ZR30 optical pod is designed for professional application in specific scenes, which has been done necessary configuration before delivery, it is forbidden to disassemble the gimbal or to change its mechanical structure. And don't add more payload to the gimbal other than its own camera. Gimbal camera is designed with very precise structure, users who approach to the equipment should have the basic knowledge of how to operate it. Irregular or irresponsible manipulations to the device may cause damage, property loss, or human injuries, and SIYI Technology is not obliged to any of the damage, loss, or injury. It is prohibited to use SIYI products for military purpose. Users under 14 years' old should follow an

experienced trainer's guide. Disassembling or modification to the system is prohibited without permission from its manufacturer, SIYI Technology.

Storage / Carrying / Recycling

When your SIYI products are stand idle, or you are bringing it outdoors, or the system reached service life, then please do read the precautions below.

CAUTION

Always place your SIYI products at places where babies or kids do not reach.

DANGER

SIYI products should be placed in places with below conditions:

Not too hot (above 60°C) or too cold (under -20°C).

Not under direct sunshine or too dusty or too wet.

Not on an unstable holder which lacks solid supports or may cause vibration.

Not nearby steam or other heat sources.

1 INTRODUCTION

1.1 Product Features

Professional UAV Imaging System

ZR30 carries an 1/2.7-inch Sony image sensor, an 8 megapixels CMOS with remarkable photosensitivity ability, impressive 4K video recording and photography. Up to 180x hybrid zoom (30x optical zoom). The scenery is clear, the algorithm is fast and accurate, and the viewpoint is automatically focused, making it easy to produce grand pictures. Silky movement, smooth zoom, distant scenery, now within reach.

*The images recorded by ZR30 will have GPS location information and time attributes.

Point To Focus

Point anywhere to focus lens from zoom camera to get clear view on selected part of screen.

Focus Tracking

Zoom camera stays focusing and keeps filming smooth videos while users are scaling images.

Starlight Night Vision

The ultra-sensitive starlight CMOS keep images bright in low light environment.

HDR

HDR (High Dynamic Range) precisely captures good details of highlights and shadows in dynamic scenes to get true colors and natural brightness.

AI Enhanced Smart Identify and Tracking

Built-in NPU neural network computing unit, combined with SIYI Technology's self-developed new AI algorithm, ZR30 optical pod will be able to automatically identify people, vehicles, ships, and other moving targets. And through the cooperation of the gimbal attitude control and flight control system, it can realize autonomous identification, positioning, and even continuous tracking. With the automatic zoom function of the visible light camera, the target will always be in the center of the screen and maintain a clear and visible screen ratio.

*AI feature is under development and can be supported by upgrade later.

540-Degree Yaw Axis Rotation

Quick Release, Fast Payload Switch

The yaw axis of ZR30 rotates in a range of 540 degrees. Hanging below VTOL drones or planes, ZR30 optical pod captures 360 degrees around. SIYI quick release structure will support more interesting payloads in the future. Welcome to follow for updates!

Incomparable Gimbal Control Interface

SIYI optical pods provide powerful compatibility to contribute to smart robotics ecology in all dimensions. They can be controlled through traditional S.Bus signal by switches and dials, or through Ethernet by touchscreen or by UDP based on SIYI SDK, or through UART by SIYI SDK or popular open-source protocols like Ardupilot driver and Mavlink.

*Developing on SIYI SDK through Ethernet UDP or UART can control SIYI optical pods by protocol and acquire relevant data.

*The Mavlink protocol control for SIYI optical pods is in development and will be supported by upgrade later.

Gimbal Motion Mode

Upside Down Mode

Gimbal automatically activates upside down mode when it is placed upside down, very convenient to be mounted on multiple kinds of vehicles like UGV, USV, robot dog, and more robotics.

Follow Mode

Horizontally, gimbal follows when aircraft rotates.

Lock Mode

Horizontally, gimbal does not follow when aircraft rotates.

FPV Mode

Gimbal rotates simultaneously as aircraft rolls to get FPV view, and output enhanced stable images.

High Accuracy and High Collaboration Control Algorithms

SIYI has made multiple breakthroughs in control algorithms and stabilization algorithms.

IMU Calibration Algorithms

Compensate and correct errors of the inertial measurement unit, reduce interference factors such as zero bias, scale factor, inter-axis error, temperature

drift, noise, etc., greatly improve the measurement accuracy of IMU, and improve the stability of the gimbal in large temperature differences, wide margin steering, and strong vibration environments.

Attitude Fusion Algorithms

Comprehensively utilize the data of sensors such as accelerometers and gyroscopes, obtain the pitch angle, roll angle, and yaw angle of the gimbal through mathematical models and filtering algorithms, and fuse this information to effectively improve system performance, stability, and robustness.

Industry-Level 3-Axis Stabilization Algorithms

Deeply integrate and utilize 3-axis gyroscopes, 3-axis accelerometers, PID controllers, motors, and magnetic encoders to achieve gimbal attitude stabilization control and continuously output stable high-definition video images during motion.

High-Precision FOC Motor Control Algorithms

Control the current components of the motor to control torque and magnetic field respectively, thereby achieving decoupling control of the brushless motor and greatly reducing picture jitter.

1.2 Parts

1.2.1 At a Glance



Interface of SIYI Quick Release Board



ZR30 Interface - Front

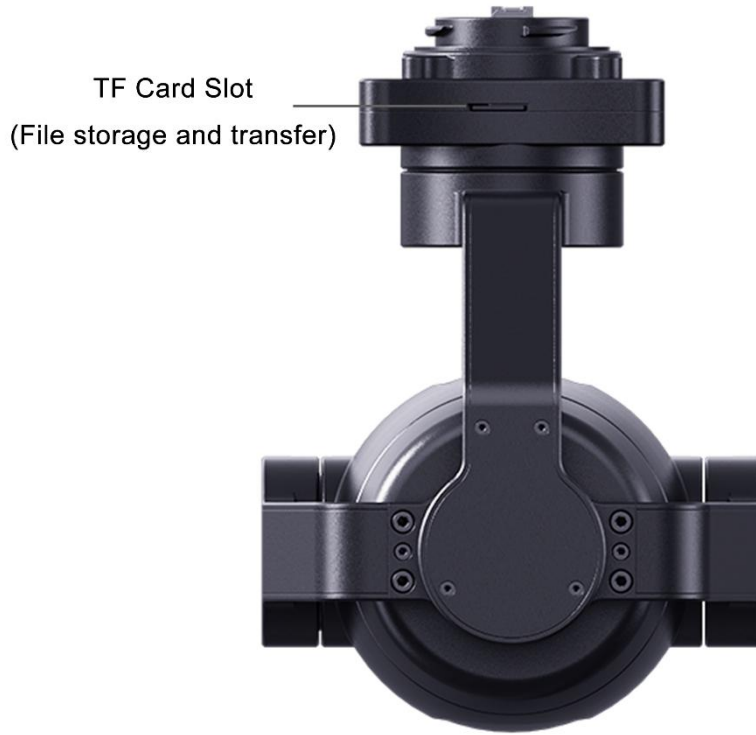

ZR30 Interface - Back

1.2.2 Pinouts

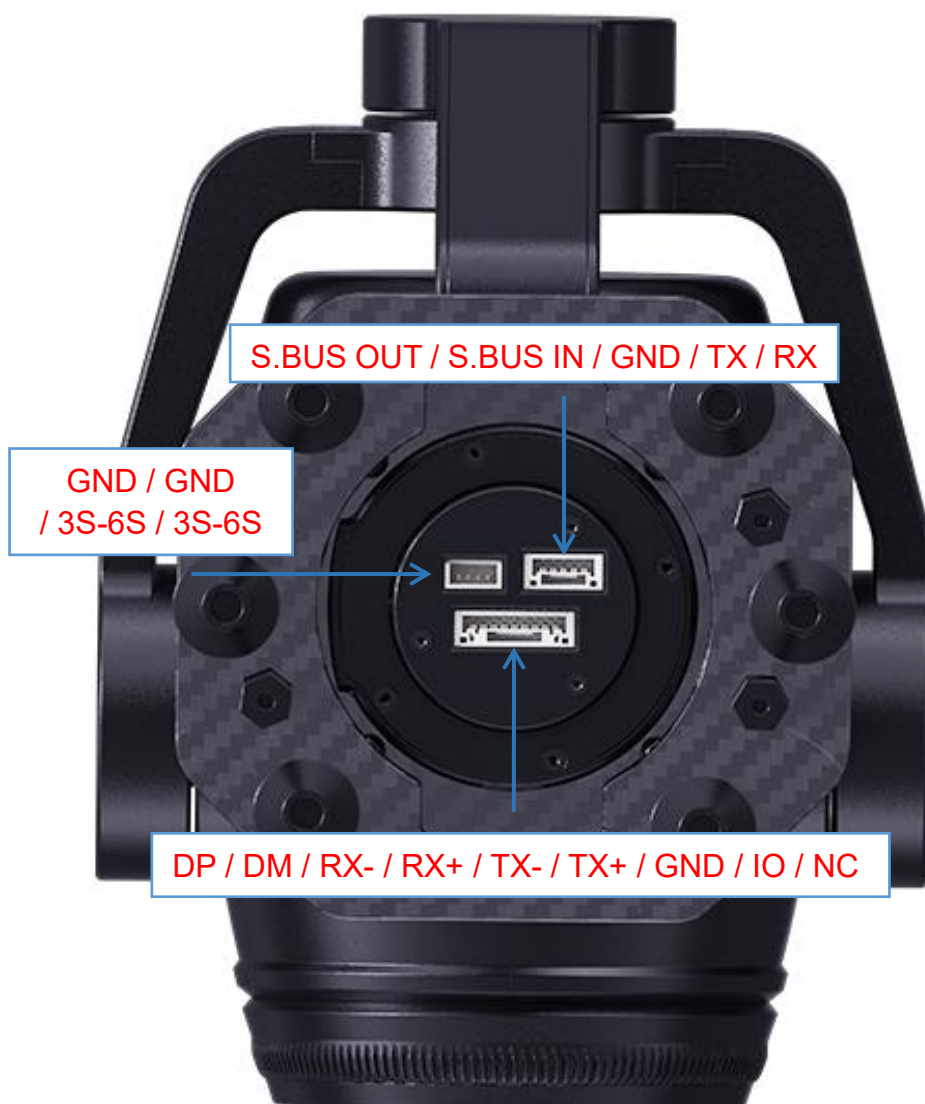

1.3 Technical Specification

Overall

Video Output Port	Ethernet, Micro-HDMI
Control Signal Input Port	S.Bus, UART, Ethernet UDP
High Accuracy 3 Axis Stabilization	Yaw, Pitch, Roll
Working Voltage	11 ~ 25.2 V
Power Consumption	Average 5 W Summit 12 W
Working Temperature	-10 ~ 50 °C
Dimension (Quick Release Board Included)	132*100*180 mm
Weight (Quick Release Board Included)	668 g

ZR30 Quick Release Anti-Vibration Board

Dimension	82*65*20 mm
Weight	38 g

Gimbal

Angular Vibration Range	±0.01°
Controllable Pitch Angle	-90° ~ +25°
Controllable Yaw Angle	-270° ~ +270°
Rotatable Roll Angle	-45° ~ +45°

Camera

Lens	30X Optical Zoom (180X Hybrid Zoom)
Focal Length	4.5±5% ~ 148.4±5% mm
Image Sensor	1/2.7 Inch, 8 MP effective resolution
Aperture	F1.3±5%~ 2.8±5%
FOV	Horizontal: 58.1°
TF Card Recording Resolution	4K (4096 x 2160) @ 25 fps 2K (2560 x 1440) @ 30 fps 1080p (1920 x 1080) @ 30 fps 720p (1280 x 720) @ 30 fps
Video Storage Bitrate	12 Mbps (H.265 Codec)
Supported File System	FAT32
Photography File Format	JPG
Video File Format	MP4
Supported TF Card Type	MicroSD Class10, max 128 GB
Still Photography Mode	Single
Metering Mode	Evaluative metering
White Balance	Automatic

Mark

To make sure that you get smoothly recorded video, please format the SD card, and make the minimum storage unit as 64 KB before recording.

1.4 Packing List

1 x ZR30 Optical Pod

1 x ZR30 Quick Release Board

1 x MK15 / HM30 Air Unit S.Bus Y Cable

(Connect SIYI MK15 and HM30 air unit's S.Bus port to acquire control signal, then one connector of the cable goes to SIYI gimbal, another goes to flight controller)

1 x 3 in 1 Control Cable

(A universal cable for ZT30, ZR30, and A8 mini, it connects SIYI gimbal's control signal port with SIYI link and controller, including UART control input, S.Bus input and output)

1 x SIYI Gimbal Power Cable

(Power supply cable for SIYI gimbal)

1 x SIYI Gimbal Ethernet Cable

(A backup cable for customer DIY purpose to connect SIYI gimbal to third-party Ethernet devices)

1 x SIYI Gimbal to SIYI Link Cable

(An all-in-one cable for only touch screen control to SIYI gimbal through SIYI link, it can power SIYI gimbal and can also transfer video stream and control signal)

1 x SIYI Gimbal Ethernet to RJ45 Cable

(Connect SIYI gimbal with RJ45 device directly)

1 x ZT30 / ZR30 Screw Pack

(Using with the fixing board to mount ZT30 quick release anti-vibration claw and ZR30 quick release anti-vibration board, including 6 x Hex Socket Large Flat Head Cap Screw TM3*8)

1.5 Indicator Definition

The status indicator on SIYI gimbal uses three different colors and different blinking frequencies to indicate the system's working or abnormal status.

- Solid Green: Normally working.
- Slow Green Blinks: S.Bus signal input is normal.
- Slow Red Blinks: One of or all the firmware does not match (camera firmware, gimbal firmware, zoom firmware).
- ● ● Triple Red Blinks: Failed to identify zoom module.
- ● ● Red-Red-Yellow Blinks Continuously: Failed to identify camera board.
- Yellow Blinks: Power input voltage is low (lower than 10 V).
- ● Double Red Blinks: IMU temperature rising is abnormal.
- ● Double Yellow Blinks: IMU temperature is rising.
- ● ● Triple Yellow Blinks: IMU temperature is abnormal.

2 GET READY TO USE ZR30

2.1 Installation

Screw Holes' Position and Distance

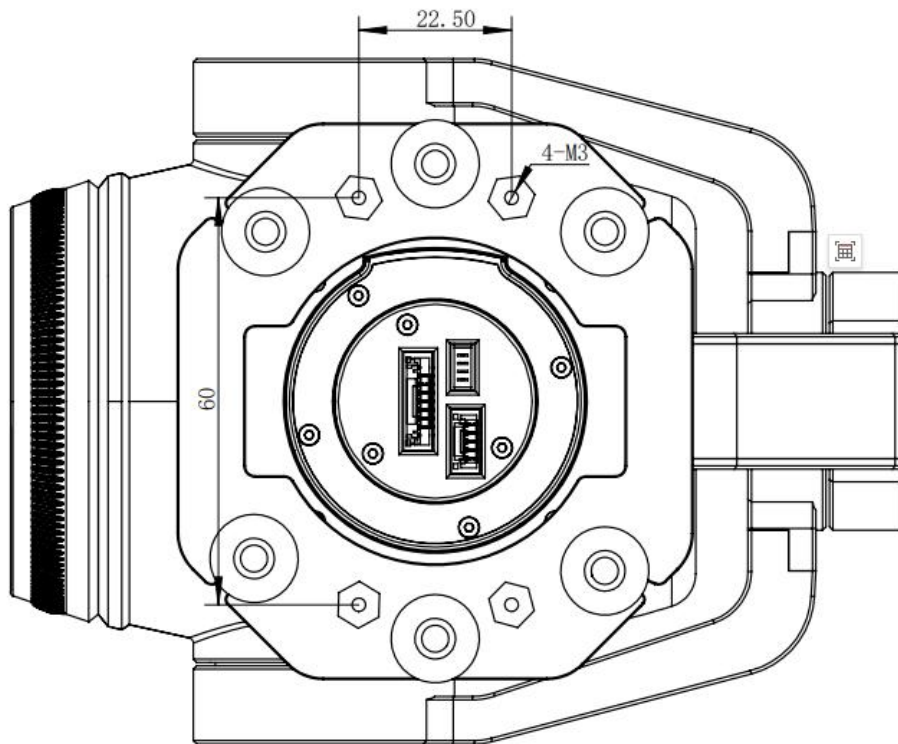

Mark

The specs of the screws for fixing the four tube screws are M.25*8 mm. Quantity: 4.

Welcome to contact SIYI to get the SIYI Gimbal 3D Model for pre-installation.

2.2 Connection and Power

SIYI optical pod and gimbal camera can be powered in many ways. If you plan to carry SIYI gimbal by your plane and the plane may roll in a wide margin, then please use connect SIYI gimbal's power port directly by a 3S to 6S power battery, not through power distribution board or air unit.

3 GIMBAL CONTROL

SIYI optical pod and gimbal camera support multiple methods to control.

3.1 Control Gimbal Camera from SIYI FPV App or SIYI QGC App on SIYI Handheld Ground Station

Gimbal connects to air unit directly to control gimbal rotation, gimbal functions, and video display in SIYI FPV app or SIYI QGC app when the air unit is communicating with the ground station.

3.1.1 Preparation

It is necessary to prepare the tools, firmware, and software below before controlling gimbal camera in this way.

- SIYI Handheld Ground Station (MK32 Standard Combo / MK15 Enterprise Standard Combo is suggested for excellent compatibility with SIYI gimbal cameras)
- ZR30 Optical Pod

Mark

Above products can be purchased from SIYI directly or from SIYI authorized dealers.

- SIYI Gimbal to SIYI Link Cable

Mark

Above tools come with product package.

- SIYI FPV App (v2.5.12.572 or latest version)
- SIYI QGC App

Mark

Above software can be downloaded from relevant product page on SIYI official website.

SIYI FPV App Steps

1. Power air unit and bind it with ground station.
2. Use SIYI Gimbal to SIYI Link Cable to connect the air unit's Ethernet port with the gimbal quick release board's Ethernet port.
3. Update SIYI FPV app to the latest.
4. Run SIYI FPV app, go to "Settings" and select the relevant SIYI camera type with main / sub stream, video stream will display. Gimbal motion and camera functions can be controlled by ground station touchscreen.

SIYI QGC App Steps

1. Power air unit and bind it with ground station.
2. Use SIYI Gimbal to SIYI Link Cable to connect the air unit's Ethernet port with the gimbal quick release board's Ethernet port.
3. Run SIYI QGC app, go to "Comm Links – Video Settings", and select "RTSP Video Stream" for "Source", then enter the default RTSP addresses of SIYI gimbal camera, video stream will display. Gimbal motion and camera functions can be controlled by ground station touchscreen.

3.1.2 Gimbal Pitch and Yaw Rotation

While SIYI FPV App or SIYI QGC app is running,

Sliding on touchscreen can control gimbal rotation. Sliding left and right are yaw rotation, up and down are gimbal pitch rotation.

Double tap touchscreen, gimbal will automatically center.

Mark

Slide on touchscreen and hold it, gimbal will continue rotating till it reaches physical limit.

Farther that you hold it from the center of the screen, faster the gimbal rotates.

3.1.3 Zoom and Focus

While SIYI FPV App or SIYI QGC app is running,

Touching “Zoom in” or “Zoom out” icon on can control the zoom camera, up to 180X hybrid zoom. Optical zoom from 1X to 30X, digital zoom from 30X to 180X.

Touching “Close Shot” or “Long Shot” icon, zoom camera focal length will change from 5 to 150 mm.

Tap touchscreen, zoom camera will focus automatically.

3.1.4 Take pictures and Record Video

While SIYI FPV App or SIYI QGC app is running,

Touch “Photo” icon once on to take a picture. Touch “Record” icon to start video recording. Touch “Recording” icon to stop video recording.

Mark

Before taking a picture or recording video, it is necessary to insert SD card into the camera.

3.2 Control Gimbal through S.Bus Signal (Taking an example of MK15 remote controller)

Gimbal camera can be connected to MK15 air unit for control through joysticks, dials, switches, and buttons on MK15 remote controller when it is communicating with the air unit.

3.2.1 Preparation

It is necessary to prepare tools, firmware, and software below before controlling gimbal camera in this way.

- MK15 Mini Handheld Ground Station (Enterprise standard combo is suggested for excellent compatibility with SIYI gimbal camera)
- ZR30 Optical Pod

Mark

Above products can be purchased from SIYI directly or from SIYI authorized dealers.

- SIYI Gimbal to SIYI Link Cable
- 3 in 1 Control Cable (For ZT30, ZR30, and A8 mini)
- MK15 / HM30 Air Unit S.Bus Y Cable

Mark

Above tools come with product package.

- Cable (USB-C to USB-A)

Mark

Above tools should be prepared by customer.

- SIYI PC Assistant (v1.3.4 or latest version)

Mark

Above software can be downloaded from relevant product page on SIYI official website.

Steps

1. Power MK15 air unit and bind it with MK15 remote controller.
2. Use SIYI Gimbal to SIYI Link Cable to connect MK15 air unit's Ethernet port with gimbal quick release board's Ethernet port.
3. Wire the 3 in 1 Control Cable with the MK15 / HM30 Air Unit S.Bus Y Cable.
4. Then use the combined cable to connect MK15 air unit's RC port and gimbal quick release board's control signal port.
5. Install and run SIYI PC Assistant on Windows computer.
6. Use the USB-C to USB-A cable to connect the gimbal to the computer, then run SIYI PC Assistant and go to "Gimbal Config" page.

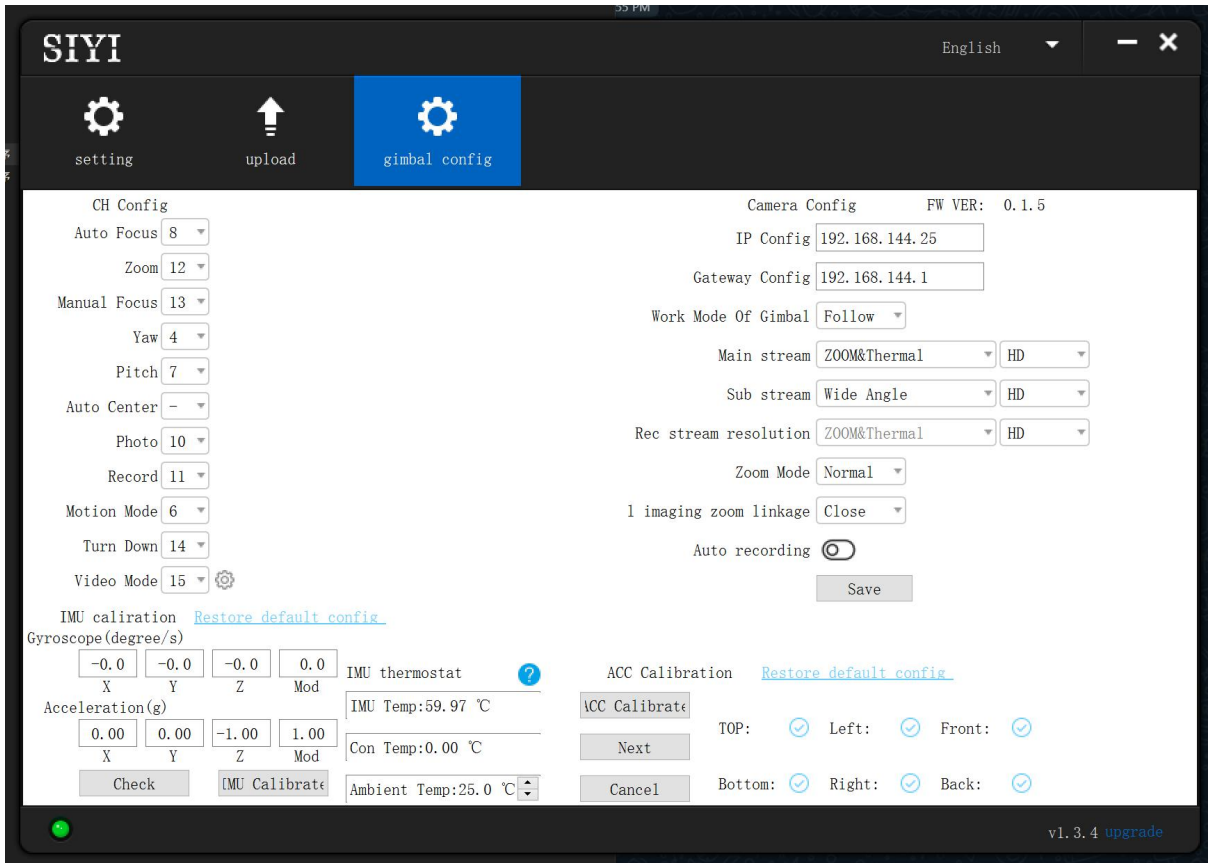

7. Under “Channel Config” page, assign remote controller channel 1 to 16 to target gimbal and camera functions according to your requirement.
8. For the assigned channels, operate their mapped joysticks, dials, switches, and buttons on MK15 remote controller to confirm if they are working normally.

3.2.2 Gimbal Pitch and Yaw Rotation (Taking an example of MK15 Dials)

Below are suggested MK15 channel mapping settings for testing, customers are free to assign MK15 channel mappings as required through SIYI TX app.

- Channel 7 = Left Dial (Reversed)
- Channel 8 = Right Dial

- Channel 12 = Button D

In SIYI PC Assistant, map “Yaw” function to channel 7 and “Pitch” to channel 8, “Center” to channel 12.

Then, if you operate the left dial on MK15 remote controller, gimbal will rotate on yaw axis. If you operate the right dial, gimbal will rotate on pitch axis. Press button D, gimbal will center itself automatically.

Mark

Hold the dial from its center position, gimbal will keep rotating unless there was a physical limit. Farther you hold it away from center, faster gimbal rotates.

3.2.3 Zoom and Focus (Taking an example of MK15 Switches)

Below is the suggested MK15 channel mapping settings for testing, customers are free to assign MK15 channel mappings as required through SIYI TX app.

- Channel 13 = Left Switch SA
- Channel 14 = Left Switch SB
- Channel 11 = Button C

In SIYI PC Assistant, map “Zoom” function to channel 13 and “Focus” to channel 14, “Auto Focus” to channel 11.

Then, if you operate the SA switch on MK15 remote controller, camera will zoom in or zoom out, optical zoom from 1X to 30X, digital zoom from 30X to 180X. If you operate the SB switch, camera will focus manually.

Press button C and camera will focus automatically.

3.2.4 Take Pictures and Record Video (Taking an Example of MK15 Buttons)

Below is the suggested MK15 channel mapping settings for testing, customers are free to assign MK15 channel mappings as required through SIYI TX app.

- Channel 9 = Button A
- Channel 10 = Button B

In SIYI PC Assistant, map “Photo” function to channel 9 and “Record” to channel 10.

Then, if you press button A on MK15 remote controller, camera will take a picture. If you press button B, camera will start or stop video recording.

Mark

Before taking pictures or recording video, it is necessary to insert SD card into the camera.

3.3 UART / UDP Control (through SDK)

SIYI gimbal camera provides control protocol for all customers. Please refer to the below guide for secondary development based on SIYI gimbal camera.

3.3.1 SDK Protocol Format

Field	Index	Bytes	Description
STX	0	2	0x6655: starting mark Low byte in the front
CTRL	2	1	0: need_ack (if the current data pack need "ack") 1: ack_pack (if the current data pack is an "ack" package) 2-7: reserved
Data_len	3	2	Date field byte length Low byte in the front
SEQ	5	2	Frame sequence (0 ~ 65535) Low byte in the front
CMD_ID	7	1	Command ID
DATA	8	Data_len	Data
CRC16		2	CRC16 check to the complete data package. Low byte in the front

3.3.2 SDK Communication Commands

Acquire Firmware Version

CMD_ID:0x01-----Acquire Firmware Version			
Send data format			
No.	Data Type	Data Name	Description
ACK data format			
	uint32_t	code_board_ver	Camera firmware version
	uint32_t	gimbal_firmware_ver	Gimbal firmware version
	uint32_t	zoom_firmware_ver	Zoom firmware version

Eg: 0x6E030203 --> firmware version v3.2.3

Mark:

1. Ignore the 4th byte (higher byte)
2. Zoom firmware version is only available for ZR10 and ZR30 at this moment.

Acquire Hardware ID

CMD_ID:0x02----- Hardware ID			
Send data format			
No.	Data Type	Data Name	Description
ACK data format			
	uint8_t	hardware_id[12]	Hardware ID character string (10 digits)

Auto Focus

CMD_ID:0x04-----Auto Focus			
Send data format			
No.	Data Type	Data Name	Description
1	uint8_t	auto_focus	1: Start auto focus for once
ACK data format			
1	uint8_t	sta	1: Success 0: Fail

Mark: Auto focus command is only available for optical zoom gimbal cameras like ZT30, ZR30, and ZR10 at this moment.

Manual Zoom and Auto Focus

CMD_ID:0x05-----Manual Zoom and Auto Focus			
Send data format			
No.	Data Type	Data Name	Data Description
1	int8_t	zoom	1: Start zooming in 0: Stop zooming in / out (send when released from control command) -1: Start zooming out
ACK data format			
	uint16_t	zoom_multiple	Current (hybrid) zoom multiples, (zoom_multiple / 10, accurate to one decimal point)

Mark:

1. Auto focus command is only available for optical zoom gimbal cameras like ZT30, ZR30, and ZR10 at this moment.
2. Under this command, A8 mini can only do manual zoom and cannot do auto focus.

Absolute Zoom and Auto Focus

CMD_ID:0x0F-----Absolute Zoom and Auto Focus			
Send data format			
No.	Data Type	Data Name	Data Description
1	uint8_t	Absolute_movement_int	Input the integer part of the target multiple (0X1 ~ 0X1E)
2	uint8_t	Absolute_movement_float	Input the fractional part of the target multiple (0X0 ~ 0X9)
ACK data format			
	uint8_t	Absolute_movement_ask	Success and return to 1

Mark:

1. Absolute zoom command is only available for optical zoom gimbal cameras like ZT30, ZR30, and ZR10 at this moment.
2. Under this command, A8 mini can only do absolute zoom and cannot do auto focus.

Acquire the Max Zoom Value

CMD_ID:0x16-----Acquire the Max Zoom Value			
Send data format			
No.	Data Type	Data Name	Description
ACK data format			
	uint8_t	zoom_max_int	Integer of the max zoom value
	uint8_t	zoom_max_float	Float of the max zoom value

Manual Focus

CMD_ID:0x06-----Manual Focus			
Send data format			
No.	Data Type	Data Name	Description
1	int8_t	focus	1: Long shot 0: Stop manual focus (send when released from control command) -1: Close shot

ACK data format			
	uint8_t	sta	1: Success 0: Fail

Mark: Auto focus command is only available for optical zoom gimbal cameras like ZT30, ZR30, and ZR10 at this moment.

Gimbal Rotation

CMD_ID:0x07-----Gimbal Rotation			
Send data format			
No.	Date Type	Date Name	Description
1	int8_t	turn_yaw	-100~0~100: Negative and positive represent two directions, higher or lower the number is away from 0, faster the rotation speed is. Send 0 when released from control command and gimbal stops rotation.
2	int8_t	turn_pitch	-100~0~100: Same as above
ACK data format			
	uint8_t	sta	1: Success 0: Fail

Center

CMD_ID:0x08-----Center			
Send data format			
No.	Data Type	Data Name	Description
1	uint8_t	center_pos	1: gimbal centers to position 0
ACK data format			
1	uint8_t	sta	1: Success 0: Fail

Acquire Gimbal Configuration Information

CMD_ID:0x0A-----Acquire Gimbal Configuration Information			
Send data format			
No.	Data Type	Data Name	Description
ACK data format			

1	uint8_t	reserved	
2	uint8_t	hdr_sta	0: HDR OFF 1: HDR ON
3	uint8_t	reserved	
4	uint8_t	record_sta	0: Recording OFF 1: Recording ON 2: TF card slot is empty 3: (Recording) Data loss in TF card recorded video, please check TF card
5	uint8_t	gimbal_motion_mode	0: Lock Mode 1: Follow Mode 2: FPV Mode
6	uint8_t	gimbal_mounting_dir	Gimbal Mounting Method 0: Reserved 1: Normal 2: Upside Down
7	uint8_t	video_hdmi_or_cvbs	(Only available on A8 mini) Video output status of HDMI and CVBS: 0: HDMI output ON CVBS output OFF 1: HDMI output OFF CVBS output ON

Function Feedback Information

CMD_ID:0x0B-----Function Feedback Information			
Send data format			
No.	Data Type	Data Name	Description
ACK data format			
1	uint8_t	info_type	0: Success 1: Fail to take a photo (Please check if TF card is inserted) 2: HDR ON 3: HDR OFF 4: Fail to record a video (Please check if TF card is inserted)

Photo and Video

CMD_ID:0x0C-----Photo			
Send data format			
No.	Data Type	Data Name	Description
	uint8_t	func_type	0: Take a picture 1: Switch on / off HDR (not supported yet) 2: Start / Stop Recording 3: Motion – Lock Mode 4: Motion – Follow Mode 5: Motion – FPV Mode 6: Set video output as HDMI (Only available on A8 mini, restart gimbal to take effect) 7: Set video output as CVBS (Only available on A8 mini, restart gimbal to take effect) 8: Turn off both HDMI and CVBS video output (Only available on A8 mini, restart gimbal to take effect)
ACK data format			
			No ack

Acquire Gimbal Attitude

CMD_ID:0x0D-----Acquire Gimbal Attitude			
Send data format			
No.	Data Type	Data Name	Description
ACK data format			
	int16_t	yaw	Yaw axis degree
	int16_t	pitch	Pitch axis degree
	int16_t	roll	Roll axis degree
	int16_t	yaw_velocity	Yaw axis rotation speed
	int16_t	pitch_velocity	Pitch axis rotation speed
	int16_t	roll_velocity	Roll axis rotation speed

Mark:

The above data to be divided by 10 is the actual degree, accuracy in one decimal place.

Set Gimbal Control Angle

CMD_ID:0x0E-----Set Gimbal Control Angle			
--	--	--	--

Send data format			
No.	Data Type	Data Name	Description
	int16_t	yaw	Target yaw angle
	int16_t	pitch	Target pitch angle
ACK data format			
	int16_t	yaw	Current yaw angle
	int16_t	pitch	Current pitch angle
	int16_t	roll	Current roll angle

Angle Control Range

Yaw:

- A8 mini: -135.0 ~ 135.0 degree
- ZR10 / ZR30: Same with A8 mini
- ZT30: Limitless

Pitch

- A8 mini: -90.0 ~ 25.0 degree
- ZR10 / ZR30 / ZT30: Same with A8 mini

Mark:

1. The accuracy of the control angle is in one decimal place. Eg: Set yaw as 60.5 degrees, the command number should be set as 605.
2. The actual angle data returned to be divided by 10 is the actual degree, accuracy in one decimal place.

Acquire Camera Image Type

CMD_ID:0x10-----Acquire Camera Image Type			
Send data format			
No.	Data Type	Data Name	Description
ACK data format			
1	uint8_t	vdisp_mode	Camera Image Mode: 0: Split Screen (Main: Zoom & Thermal. Sub: Wide Angle) 1: Split Screen (Main: Wide Angle & Thermal. Sub: Zoom) 2: Split Screen (Main: Zoom & Wide Angle. Sub: Thermal) 3: Single Image (Main: Zoom. Sub: Thermal) 4: Single Image (Main: Zoom. Sub: Wide Angle) 5: Single Image (Main: Wide Angle. Sub: Thermal) 6: Single Image (Main: Wide Angle. Sub: Zoom) 7: Single Image (Main: Thermal. Sub: Zoom) 8: Single Image (Main: Thermal. Sub: Wide Angle)

Mark: Acquire camera image type command is only available for ZT30 at this moment.

Set Camera Image Type

CMD_ID:0x11-----Set Camera Image Type			
Send data format			
No.	Data Type	Data Name	Description
1	uint8_t	vdisp_mode	Camera Image Mode: 0: Split Screen (Main: Zoom & Thermal. Sub: Wide Angle) 1: Split Screen (Main: Wide Angle & Thermal. Sub: Zoom) 2: Split Screen (Main: Zoom & Wide Angle. Sub: Thermal) 3: Single Image (Main: Zoom. Sub: Thermal) 4: Single Image (Main: Zoom. Sub: Wide Angle) 5: Single Image (Main: Wide Angle. Sub: Thermal) 6: Single Image (Main: Wide Angle. Sub: Zoom) 7: Single Image (Main: Thermal. Sub: Zoom) 8: Single Image (Main: Thermal. Sub: Wide Angle)
ACK data format			
1	uint8_t	vdisp_mode	Camera Image Mode: 0: Split Screen (Main: Zoom & Thermal. Sub: Wide Angle) 1: Split Screen (Main: Wide Angle & Thermal. Sub: Zoom) 2: Split Screen (Main: Zoom & Wide Angle. Sub: Thermal) 3: Single Image (Main: Zoom. Sub: Thermal) 4: Single Image (Main: Zoom. Sub: Wide Angle) 5: Single Image (Main: Wide Angle. Sub: Thermal) 6: Single Image (Main: Wide Angle. Sub: Zoom) 7: Single Image (Main: Thermal. Sub: Zoom) 8: Single Image (Main: Thermal. Sub: Wide Angle)

Mark: Set camera image type command is only available for ZT30 at this moment.

Read Temperature of a Point

CMD_ID:0x12-----Read Temperature of a Point			
Send data format			
No.	Data Type	Data Name	Description

1	uint16_t	x	X coordinate of the point
2	uint16_t	y	Y coordinate of the point
3	uint8_t	get_temp_flag	0: Turn off temperature measuring 1: Measure the temperature once 2: Continuous temperature measuring at 5 Hz
ACK data format			
1	uint16_t	temp	Temperature of the point / 100 (two decimal places)
2	uint16_t	x	X coordinate of the point
3	uint16_t	y	Y coordinate of the point

Mark: Read temperature of a point command is only available for ZT30 at this moment.

Read Temperature of a Box on Screen

CMD_ID:0x13-----Read Temperature of a Box on Screen			
Send data format			
No.	Data Type	Data Name	Description
1	uint16_t	startx	X coordinate of the starting point of the box
2	uint16_t	starty	Y coordinate of the starting point of the box
3	uint16_t	endx	X coordinate of the ending point of the box
4	uint16_t	endy	Y coordinate of the ending point of the box
5	uint8_t	get_temp_flag	0: Turn off temperature measuring 1: Measure the temperature once 2: Continuous temperature measuring at 5 Hz
ACK data format			
1	uint16_t	startx	X coordinate of the starting point of the box
2	uint16_t	starty	Y coordinate of the starting point of the box
3	uint16_t	endx	X coordinate of the ending point of the box
4	uint16_t	endy	Y coordinate of the ending point of the box
5	uint16_t	temp_max	Max temperature in the box / 100 (two decimal places)
6	uint16_t	temp_min	Min temperature in the box / 100 (two decimal places)
7	uint16_t	temp_max_x	X coordinate of the max temperature in the box
8	uint16_t	temp_max_y	Y coordinate of the max temperature in the box
9	uint16_t	temp_min_x	X coordinate of the min temperature in

			the box
10	uint16_t	temp_min_x	Y coordinate of the min temperature in the box

Mark:

1. Thermal camera supports digital zoom, the temperature measuring box will zoom in and out according to the digital zoom. Under digital zoom, the temperature measuring range should refer to the box responded by the camera.
2. Read temperature of a box command is only available for ZT30 at this moment.

Read Temperature of the Full Screen

CMD_ID:0x14-----Read Temperature of the Full Screen			
Send data format			
No.	Data Type	Data Name	Description
1	uint8_t	get_temp_flag	0: Turn off temperature measuring 1: Measure the temperature once 2: Continuous temperature measuring at 5 Hz
ACK data format			
1	uint16_t	temp_max	Max temperature of the full screen / 100 (two decimal places)
2	uint16_t	temp_min	Min temperature of the full screen / 100 (two decimal places)
3	uint16_t	temp_max_x	X coordinate of the max temperature in the full screen
4	uint16_t	temp_max_y	Y coordinate of the max temperature in the full screen
5	uint16_t	temp_min_x	X coordinate of the min temperature in the full screen
6	uint16_t	temp_min_x	Y coordinate of the min temperature in the full screen

Mark: Read temperature of the full screen is only available for ZT30 at this moment.

Read Range from Laser Rangefinder

CMD_ID:0x15-----Read Range from Laser Rangefinder			
Send data format			
No.	Data Type	Data Name	Description
ACK data format			
1	uint16_t	info_type	Range from Laser Rangefinder low byte in the front, high byte in the back Minimum value is 50 Data unit is dm

Mark: Read range from laser rangefinder is only available for ZT30 at this moment.

3.3.3 SIYI Gimbal Camera SDK Communication Interface

TTL Serial Port

- Baud rate: 115200
- Data position: 8 digits. Stop position: 1 digit. No check.

UDP

- IP: 192.168.144.25
- Port Number: 37260

TCP

- IP: 192.168.144.25
- Port Number: 37260
- Heartbeat Package Data: 55 66 01 01 00 00 00 00 00 59 8B

3.3.4 SIYI Gimbal Camera SDK Communication Code Examples

Zoom 1

55 66 01 01 00 00 00 05 01 8d 64

Zoom -1

55 66 01 01 00 00 00 05 FF 5c 6a

Absolute Zoom (4.5X)

55 66 01 02 00 01 00 0F 04 05 60 BB

Acquire the Max Zoom Value

55 66 01 00 00 00 00 16 B2 A6

Manual Focus 1

55 66 01 01 00 00 00 06 01 de 31

Manual Focus -1

55 66 01 01 00 00 00 06 ff 0f 3f

Take Pictures

55 66 01 01 00 00 00 0c 00 34 ce

Record Video

55 66 01 01 00 00 00 0c 02 76 ee

Rotate 100 100

55 66 01 02 00 00 00 07 64 64 3d cf

Auto Centering

55 66 01 01 00 00 00 08 01 d1 12

Gimbal Status Information

55 66 01 00 00 00 00 0a 0f 75

Auto Focus

55 66 01 01 00 00 00 04 01 bc 57

Acquire Hardware ID

55 66 01 00 00 00 00 02 07 f4

Acquire Firmware Version

55 66 01 00 00 00 00 01 64 c4

Lock Mode

55 66 01 01 00 00 00 0c 03 57 fe

Follow Mode

55 66 01 01 00 00 00 0c 04 b0 8e

FPV Mode

55 66 01 01 00 00 00 0c 05 91 9e

Acquire Attitude Data

55 66 01 00 00 00 00 0d e8 05

Set Video Output as HDMI (Only available on A8 mini, restart to take effect)

55 66 01 01 00 00 00 0c 06 f2 ae

Set Video Output as CVBS (Only available on A8 mini, restart to take effect)

55 66 01 01 00 00 00 0c 07 d3 be

Turn Off both CVBS and HDMI Output (Only available on A8 mini, restart to take effect)

55 66 01 01 00 00 00 0c 08 3c 4f

Read Range from Laser Rangefinder (Low byte in the front, high byte in the back, available on ZT30)

55 66 01 00 00 00 00 15 D1 96

3.3.5 SDK CRC16 Code

```

const uint16_t crc16_tab[256];
/*****
CRC16 Coding & Decoding G(X) = X^16+X^12+X^5+1
*****/
uint16_t CRC16_cal(uint8_t *ptr, uint32_t len, uint16_t crc_init)
{
    uint16_t crc,   oldcrc16;
    uint8_t  temp;
    crc = crc_init;
    while (len--!=0)
    {
        temp=(crc>>8)&0xff;
        oldcrc16=crc16_tab[*ptr^temp];
        crc=(crc<<8)^oldcrc16;
        ptr++;
    }
    //crc=~crc;    //??
    return(crc);
}

uint8_t crc_check_16bites(uint8_t* pbuf, uint32_t len,uint32_t* p_result)
{
    uint16_t crc_result = 0;
    crc_result= CRC16_cal(pbuf,len, 0);
    *p_result = crc_result;

    return 2;
}

const uint16_t crc16_tab[256]= {0x0,0x1021,0x2042,0x3063,0x4084,0x50a5,0x60c6,0x70e7,
                                0x8108,0x9129,0xa14a,0xb16b,0xc18c,0xd1ad,0xe1ce,0xf1ef,
                                0x1231,0x2210,0x3273,0x4252,0x52b5,0x6294,0x72f7,0x82d6,
                                0x9339,0xa318,0xb37b,0xc35a,0xd3bd,0xe39c,0xf3ff,0xe3de,
                                0x2462,0x3443,0x4420,0x5401,0x64e6,0x74c7,0x84a4,0x9485,
                                0xa56a,0xb54b,0xc528,0xd509,0xe5ee,0xf5cf,0xc5ac,0xd58d,
                                0x3653,0x4672,0x5611,0x6630,0x76d7,0x86f6,0x9695,0xa6b4,
                                0xb75b,0xa77a,0x9719,0x8738,0xf7df,0xe7fe,0xd79d,0xc7bc,
                                0x48c4,0x58e5,0x6886,0x78a7,0x8840,0x1861,0x2802,0x3823,
                                0xc9cc,0xd9ed,0xe98e,0xf9af,0x8948,0x9969,0xa90a,0xb92b,
                                0x5af5,0x4ad4,0x7ab7,0x6a96,0x1a71,0xa50,0x3a33,0x2a12,

```

```
0xdbfd,0xcdbc,0xfbbf,0xeb9e,0x9b79,0x8b58,0xbb3b,0xab1a,
0x6ca6,0x7c87,0x4ce4,0x5cc5,0x2c22,0x3c03,0xc60,0x1c41,
0xedaе,0xfd8f,0xcdec,0xddcd,0xad2a,0xbd0b,0x8d68,0x9d49,
0x7e97,0x6eb6,0x5ed5,0x4ef4,0x3e13,0x2e32,0x1e51,0xe70,
0xff9f,0xefbe,0xdfdd,0xcffc,0xbf1b,0xaf3a,0x9f59,0x8f78,
0x9188,0x81a9,0xb1ca,0xa1eb,0xd10c,0xc12d,0xf14e,0xe16f,
0x1080,0xa1,0x30c2,0x20e3,0x5004,0x4025,0x7046,0x6067,
0x83b9,0x9398,0xa3fb,0xb3da,0xc33d,0xd31c,0xe37f,0xf35e,
0x2b1,0x1290,0x22f3,0x32d2,0x4235,0x5214,0x6277,0x7256,
0xb5ea,0xa5cb,0x95a8,0x8589,0xf56e,0xe54f,0xd52c,0xc50d,
0x34e2,0x24c3,0x14a0,0x481,0x7466,0x6447,0x5424,0x4405,
0xa7db,0xb7fa,0x8799,0x97b8,0xe75f,0xf77e,0xc71d,0xd73c,
0x26d3,0x36f2,0x691,0x16b0,0x6657,0x7676,0x4615,0x5634,
0xd94c,0xc96d,0xf90e,0xe92f,0x99c8,0x89e9,0xb98a,0xa9ab,
0x5844,0x4865,0x7806,0x6827,0x18c0,0x8e1,0x3882,0x28a3,
0xcb7d,0xdb5c,0xeb3f,0xfb1e,0x8bf9,0x9bd8,0xabbb,0xbb9a,
0x4a75,0x5a54,0x6a37,0x7a16,0xaf1,0x1ad0,0x2ab3,0x3a92,
0xfd2e,0xed0f,0xdd6c,0xcd4d,0xbdaa,0xad8b,0x9de8,0x8dc9,
0x7c26,0x6c07,0x5c64,0x4c45,0x3ca2,0x2c83,0x1ce0,0xcc1,
0xef1f,0xff3e,0xcf5d,0xdf7c,0xaf9b,0xbfba,0x8fd9,0x9ff8,
0x6e17,0x7e36,0x4e55,0x5e74,0x2e93,0x3eb2,0xed1,0x1ef0
```

};

3.3.6 Advanced Guide for SIYI Gimbal SDK Integration

This special guide is to help developers (especially whose development is based on Linux platform) use SIYI gimbal SDK.

Mark

Before using the guide, please do read the chapter 3.3.1 to 3.3.5 of the user manual.

This guide is using UDP protocol:

1. Go to chapter 3.3.4 of this manual for SIYI Gimbal Camera SDK Communication Code Examples and fill your required examples to "send_buff" following the below format in hexadecimal.

```
int sockfd;
int ret, i, recv_len;
struct sockaddr_in send_addr, recv_addr;
unsigned char send_buf[] = {0x55,0x66,0x01,0x01,0x00,0x00,0x00,0x00,0x08,0x01,0xd1,0x12}; //对应功能的帧协议,十六进制数据
unsigned char recv_buf[RECV_BUUF_SIZE] = {0};

/* 创建udp套接字
```

2. Chang the gimbal camera's server port and IP addresses to what you need. The double quotation marks of the IP addresses should be kept.

```
#define SERVER_PORT    37260           //云台相机（服务端）端口号
#define SERVER_IP     "192.168.1.25"  //云台相机（服务端）IP
```

3. Create a socket keyword.

```
/* 创建UDP套接字
   AF_INET:    ipv4地址
   SOCK_DGRAM: UDP 协议
   0:          自动选择类型对应的默认协议
*/
if ((sockfd = socket(AF_INET, SOCK_DGRAM, 0)) < 0) {
    perror("socket");
    exit(1);
}
```

4. Send data to the gimbal camera and do not revise.

```
/* 发送帧数据
   sockfd:      socket套接字文件描述符
   send_buf:    要发送的数据在内存中的首地址
   sizeof(send_buf): 要发送的数据的长度
   0:           发送标志, 一般为0
   (struct sockaddr *)&send_addr: 数据接收端的地址 (包含IP地址和端口号) 的结构体指针
   addr_len:    数据接收端地址结构体的大小
*/
printf("Send HEX data\n");
socklen_t addr_len = sizeof(struct sockaddr_in);
if(sendto(sockfd, send_buf, sizeof(send_buf), 0, (struct sockaddr *)&send_addr, addr_len) < 0)
{
    perror("sendto");
    exit(1);
}
```

5. Receive data responded by the gimbal camera and do not revise.

```
/* 发送帧数据
   sockfd:      socket套接字文件描述符
   send_buf:    要发送的数据在内存中的首地址
   sizeof(send_buf): 要发送的数据的长度
   0:           发送标志, 一般为0
   (struct sockaddr *)&send_addr: 数据接收端的地址 (包含IP地址和端口号) 的结构体指针
   addr_len:    数据接收端地址结构体的大小
*/
printf("Send HEX data\n");
socklen_t addr_len = sizeof(struct sockaddr_in);
if(sendto(sockfd, send_buf, sizeof(send_buf), 0, (struct sockaddr *)&send_addr, addr_len) < 0)
{
    perror("sendto");
    exit(1);
}
```

6. Print the received data in hexadecimal and do not revise.

```
// 十六进制形式打印接收到的数据
printf("Received HEX data: ");
for (int i = 0; i < recv_len; i++)
{
    printf("%02x ", recv_buf[i]);
}
printf("\n");
```

7. Following the above steps, compile and run the SDK and you will see the printed data below, which means data can be sent and received normally. At this moment, please observe if the gimbal camera executes the relevant actions.

```
yang@ubuntu:~/_star$ gcc siyi.c -o siyi
yang@ubuntu:~/_star$ ./siyi
Send HEX data
Received HEX data: 55 66 02 01 00 08 00 08 01 90 4f
yang@ubuntu:~/_star$
```

Mark

Before using the SDK to communicate with the gimbal camera in UDP protocol, please do make sure that the device and the gimbal camera are in the same gateway, which means that ubuntu can ping the gimbal camera's IP addresses successfully.

If they still didn't communicate, the possible reason is that the Windows firewall is interrupting the sending and receiving of data, then try to disable Windows firewall temporarily.

Relevant Code Examples

```
#include <stdio.h>
#include <stdlib.h>
#include <string.h>
#include <errno.h>
#include <sys/socket.h>
#include <netinet/in.h>
#include <arpa/inet.h>
#include <unistd.h>

#define RECV_BUUF_SIZE    64
#define SERVER_PORT      37260           // Gimbal Camera (Server) Port
#define SERVER_IP        "192.168.144.25" // Gimbal Camera (Server) IP Addresses

int main(int argc, char *argv[])
{
    int sockfd;
    int ret, i, recv_len;
    struct sockaddr_in send_addr, recv_addr;
    unsigned char send_buf[] = {0x55,0x66,0x01,0x01,0x00,0x00,0x00,0x08,0x01,0xd1,0x12}; // Frame
    protocol of the relevant functions in hexadecimal
    unsigned char recv_buf[RECV_BUUF_SIZE] = {0};

    /* Create UDP Socket
       AF_INET:    ipv4 addresses
       SOCK_DGRAM: UDP protocol
       0:         automatically choose the default protocol of the relevant type
    */
    if ((sockfd = socket(AF_INET, SOCK_DGRAM, 0)) < 0) {
        perror("socket");
        exit(1);
    }
```

```

}

/* Set IP addresses and port number of gimbal camera
   sin_family:          ipv4 addresses
   sin_addr.s_addr:    IP addresses of gimbal camera
   sin_port:           port of gimbal camera
*/
memset(&send_addr, 0, sizeof(send_addr));
send_addr.sin_family = AF_INET;
send_addr.sin_addr.s_addr = inet_addr(SERVER_IP);
send_addr.sin_port = htons(SERVER_PORT);

/* Send frame data
   sockfd:              descriptor of socket
   send_buf:           head address in RAM of the sending data
   sizeof(send_buf):   length of sending data
   0:                  sending mark, usually it is 0
   (struct sockaddr *)&send_addr: structure pointer of the receiving data addresses
(including IP addresses and port)
   addr_len:           structure size of the receiving data addresses
*/
printf("Send HEX data\n");
socklen_t addr_len = sizeof(struct sockaddr_in);
if(sendto(sockfd, send_buf, sizeof(send_buf), 0, (struct sockaddr *)&send_addr, addr_len) < 0)
{
    perror("sendto");
    exit(1);
}

/* Receive the responding data from gimbal camera
   sockfd:              descriptor of "sockfd" socket
   recv_buf:           head address in RAM of the responding data
   RECV_BUUF_SIZE:    size of the buffer, which is the length of the max data to
receive
   0:                  receiving mark, usually it is 0
   (struct sockaddr *)&recv_addr: the target structure will be filled with addresses (including
IP addresses and port) from the data sender
   &addr_len:          the target storage position, the structure size of
"src_addr" and "addrlen" should be filled before calling, the actual size of the sender will be filled after calling
*/
recv_len = recvfrom(sockfd, recv_buf, RECV_BUUF_SIZE, 0, (struct sockaddr *)&recv_addr,
&addr_len);
if (recv_len < 0) {
    perror("recvfrom");
}

```



```
        exit(1);
    }

    // print the received data in hexadecimal
    printf("Received HEX data: ");
    for (int i = 0; i < recv_len; i++)
    {
        printf("%02x ", recv_buf[i]);
    }
    printf("\n");

    // close socket
    close(sockfd);

    return 0;
}
```

3.4 Control SIYI Gimbal Camera in SIYI QGC Windows Software through HM30 Image Transmission System

Gimbal camera connects to air unit directly to control gimbal rotation, gimbal functions, and video display in SIYI QGC Windows software when the air unit is communicating with the ground unit.

3.4.1 Preparation

It is necessary to prepare tools, firmware, and software below before controlling gimbal camera in this way.

- SIYI HM30 Full HD Image Transmission System

- ZR30 Optical Pod

Mark

Above products can be purchased from SIYI directly or from SIYI authorized dealers.

- SIYI Gimbal to SIYI Link Cable
- HM30 Ground Unit LAN to RJ45 Cable

Mark

Above tools come with product package.

- SIYI QGC Windows Software

Mark

Above software can be downloaded from relevant product page on SIYI official website.

Steps

1. Power air unit and bind it with ground unit.
2. Use SIYI Gimbal to SIYI Link Cable to connect the air unit's Ethernet port with the gimbal quick release board's Ethernet port.
3. Then use HM30 Ground Unit LAN to RJ45 cable to connect the ground unit's LAN port with the computer's RJ45 port.

4. Modify the computer’s Ethernet settings to have the same gateway with SIYI link and avoid IP addresses conflict.

For example, let’s assign “192.168.144.30” for the computer IP addresses.

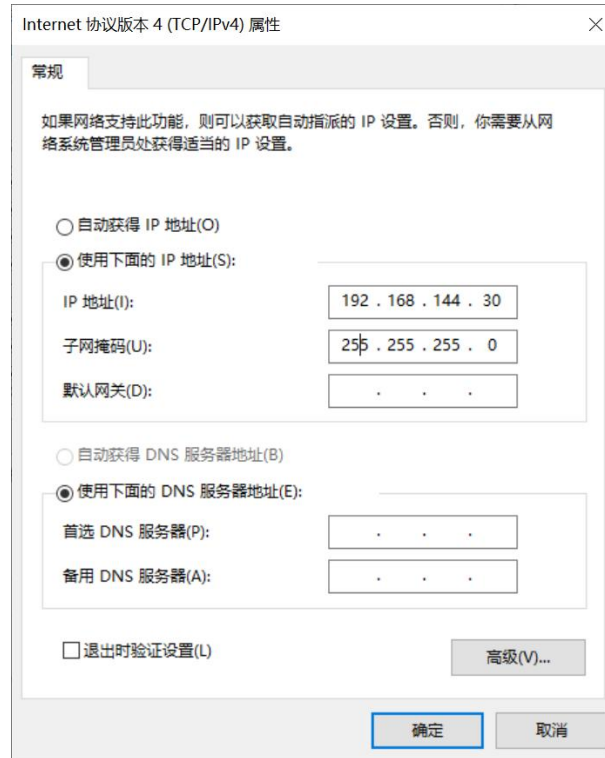

5. Run SIYI QGC Windows software, go to “Comm Links – Video Settings”, and select “RTSP Video Stream” for “Source”, then enter the default RTSP addresses of SIYI gimbal camera, video stream will display. Gimbal motion and camera functions can be controlled by mouse in QGroundControl.

3.4.2 Gimbal Pitch and Yaw Rotation

While SIYI QGC Windows software is running,

Drag the mouse on screen can control gimbal rotation. Dragging the mouse left and right are yaw rotation, up and down are pitch rotation.

Double click the mouse on screen, gimbal will automatically center.

Mark

Drag the mouse on screen and hold it, gimbal will continue rotating unless there is a physical limit. Farther you hold it from the center of the screen, faster the gimbal rotates.

3.4.3 Zoom and Focus

While SIYI QGC Windows software is running,

Clicking “Zoom in” or “Zoom out” icon on can control the zoom camera, up to 180X hybrid zoom. Optical zoom from 1X to 30X, digital zoom from 30X to 180X. Clicking “Close Shot” or “Long Shot” icon, zoom camera focal length will change.

Click on screen, zoom camera will focus automatically.

3.4.4 Take pictures and Record Video

While SIYI QGC Windows software is running,

Click “Photo” icon once on to take a picture. Click “Record” icon to start video recording. Click “Recording” icon to stop video recording.

Mark

Before taking a picture or recording video, it is necessary to insert SD card into gimbal camera.

3.5 Control SIYI Gimbal Camera by the Ardupilot Driver through UART

Gimbal camera's UART port connects to Ardupilot flight controller's UART port directly to communicate with the flight controller and to control gimbal rotation, gimbal functions, and camera functions.

Preparation

It is necessary to prepare the tools, firmware, and software below before controlling gimbal camera in this way.

- Ardupilot Flight Controller (v4.3.1 and above firmware)
- ZR30 Optical Pod

Mark

Above products can be purchased from SIYI directly or from SIYI authorized dealers.

- SIYI Gimbal to Ardupilot Flight Controller UART Cable

Mark

Above tools should be made by customers.

Please refer to the below picture for pinouts and diagram.

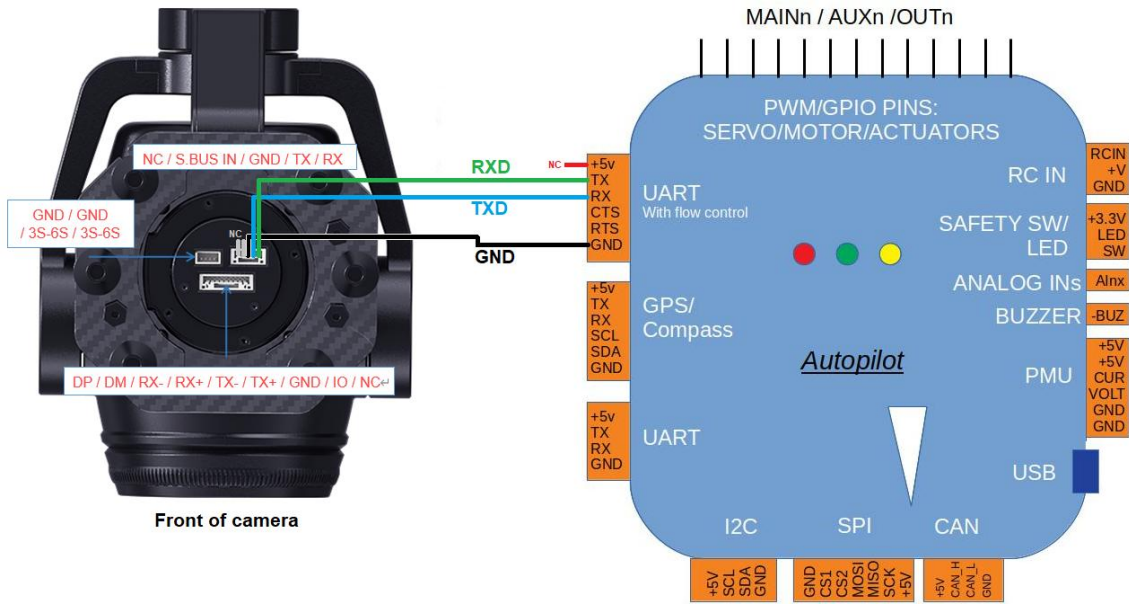

- SIYI QGC Windows Software

Mark

Above software can be downloaded from relevant product page on SIYI official website.

Steps

1. Power SIYI gimbal camera and Ardupilot flight controller.
2. Connect gimbal camera's UART port to Ardupilot flight controller's UART port and make sure they are communicating with each other.
3. Run ground station and set the following parameters.

The params below assume the autopilot's telem2 port is used and the Camera1 control instance.

- SERIAL2_PROTOCOL to 8 ("SToRM32 Gimbal Serial")
- SERIAL2_BAUD to "115" for 115200 bps

- MNT1_TYPE to “8” (“SIYI”) and reboot the ardupilot
- MNT1_PITCH_MIN to -90
- MNT1_PITCH_MAX to 25
- MNT1_YAW_MIN to -80
- MNT1_YAW_MAX to 80
- MNT1_RC_RATE to 90 (deg/s) to control speed of gimbal when using RC targetting
- CAN1_TYPE to 4 (Mount / SIYI) to allow control of the camera.
- RC6_OPTION = 213 (“Mount Pitch”) to control the gimbal’s pitch angle with RC channel 6
- RC7_OPTION = 214 (“Mount Yaw”) to control the gimbal’s yaw angle with RC channel 7
- RC8_OPTION = 163 (“Mount Lock”) to switch between “lock” and “follow” mode with RC channel 8

Optionally these auxiliary functions are also available.

- RC9_OPTION = 166 (“Camera Record Video”) to start/stop recording of video
- RC9_OPTION = 167 (“Camera Zoom”) to zoom in and out
- RC9_OPTION = 168 (“Camera Manual Focus”) to adjust focus in and out
- RC9_OPTION = 169 (“Camera Auto Focus”) to trigger auto focus

4 VIDEO OUTPUT

ZR30 optical pod supports both Ethernet and HDMI port for outputting video stream.

Mark

ZR30's Ethernet port and HDMI port can output video stream simultaneously.

4.1 Output and Display Video on SIYI Handheld Ground Station

Gimbal camera can connect to the air unit directly, then video will be displayed in SIYI FPV app or SIYI QGC app or other app that are compatible with SIYI link and SIYI gimbal camera when the air unit is communicating with the ground station.

Please refer to chapter 3.1 of this manual for more detail.

4.2 Output Video Stream to Android Device through HM30 Full HD Image Transmission System

Gimbal camera connects to HM30 air unit directly, then video will be displayed in SIYI FPV app or SIYI QGC app or other app that are compatible with SIYI link and SIYI gimbal camera when the air unit is communicating with the ground unit.

Preparation

It is necessary to prepare the tools, firmware, and software below before outputting video stream in this way.

- HM30 Full HD Image Transmission System
- ZR30 Optical Pod

Mark

Above products can be purchased from SIYI directly or from SIYI authorized dealers.

- SIYI Gimbal to Link Cable

Mark

Above tools come with product package.

- SIYI FPV App (v2.5.12.572 or latest version)
- SIYI QGC App

Mark

Above software can be downloaded from relevant product page on SIYI official website.

SIYI FPV App Steps

1. Power air unit and bind it with ground unit.

2. Use SIYI Gimbal to SIYI Link Cable to connect the air unit's Ethernet port with the gimbal quick release board's Ethernet port.
3. Update SIYI FPV app to the latest.
4. Run SIYI FPV app, go to "Settings" and select the relevant SIYI camera type with main / sub stream, video stream will display. Gimbal motion and camera functions can be controlled by app touchscreen.

SIYI QGC App Steps

1. Power air unit and bind it with ground unit.
2. Use SIYI Gimbal to SIYI Link Cable to connect the air unit's Ethernet port with the gimbal quick release board's Ethernet port.
3. Run SIYI QGC app, go to "Comm Links – Video Settings", and select "RTSP Video Stream" for "Source", then enter the default RTSP addresses of SIYI gimbal camera, video stream will display. Gimbal motion and camera functions can be controlled by ground station touchscreen.

4.3 Output Video Stream to Windows Device through HM30 Full HD Image Transmission System

Gimbal camera connects to HM30 air unit directly, then video will be displayed in SIYI QGC Windows software when the air unit is communicating with the ground unit.

Please refer to chapter 3.4 of this manual for details.

4.4 Output Video to Windows Device Directly

Gimbal camera connects to Windows device directly, then video will be displayed in SIYI QGC Windows software.

Preparation

It is necessary to prepare the tools, firmware, and software below before outputting video stream in this way.

- ZR30 Optical Pod

Mark

Above products can be purchased from SIYI directly or from SIYI authorized dealers.

- SIYI Gimbal Ethernet to RJ45 Cable

Mark

Above tools come with product package.

- SIYI QGC Windows Software

Mark

Above software can be downloaded from relevant product page on SIYI official website.

Steps

1. Power gimbal camera.
2. Use SIYI Gimbal Ethernet to RJ45 Cable to connect the gimbal quick release board's Ethernet port to Windows device's RJ45 port. If your computer does not come with RJ45 port, it is suggested to use an RJ45 to USB converter.
3. Modify the computer's Ethernet settings to have the same gateway with SIYI link and avoid IP addresses conflict.

For example, let's assign "192.168.144.30" for the computer IP addresses.



4. Run SIYI QGC Windows software, go to "Comm Links – Video Settings", and select "RTSP Video Stream" for "Source", then enter the default RTSP addresses of SIYI gimbal camera, video stream will display. Gimbal motion and camera functions can be controlled by mouse in QGroundControl.

4.5 Output Video to Third-Party Link

SIYI gimbal camera can output video to any third-party link which provides Ethernet port and is compatible with RTSP video stream.

In this way, it is necessary to prepare a customized video cable for connection between SIYI gimbal camera and the third-party link.



CAUTION

SIYI gimbal camera Ethernet port's "RX-" pinout should connect to the third-party link Ethernet port's "RX-" pinout, and "RX+" pinout to "RX+" pinout. Do not cross the pinouts, otherwise it will cause damage to the device.

Steps

1. Power the air unit of the third-party link and bind it with the ground unit.
2. Use the video cable to connect SIYI gimbal camera's Ethernet port and the third-party link's Ethernet port.
3. Open RTSP video player and input SIYI gimbal camera's default RTSP addresses, if connection is successful, video will display normally.



Mark

SIYI QGC Android app and Windows software support video display from third-party

links as well.

4.6 Output by HDMI

ZR30 can output video to any HDMI monitor or to third-party link which support HDMI input through the Micro-HDMI port.

Mark

The default video output mode of ZR30 is Ethernet.

Go to the “Gimbal Config” page in SIYI Assistant program to change the video output mode to “HDMI”, then ZR30 will stream from its Micro-HDMI port on the quick release board.

When ZR30 is outputting video to a third-party link through HDMI, SIYI FPV and SIYI FPV app cannot control the gimbal by touchscreen. Please use S.Bus or UART control instead.

4.7 Solutions to No Image

If gimbal camera failed to output video or the video cannot be displayed properly, please follow the steps below for trouble shooting.

1. Confirm if the link’s ground unit is communicating with the air unit and if the camera is connected to the air unit.
2. Check Camera IP addresses and RTSP addresses.

3. If you are using SIYI FPV app, check the connection status, app version, video stream settings.
4. If you are using SIYI handheld ground stations, check the Ethernet switch in Android system.
5. Please double check if the gimbal camera's IP addresses was modified accidentally.

If video still does not show up, please follow the steps below and make a deep investigation according to the video output mode, the video display device, and the application / software you are using.

4.7.1 Video Output to Android Device

1. Input SIYI gimbal's default IP addresses "192.168.144.25" in the "Ping Tools" app and check if the network communication is successful. If the tool responds, then check if the RTSP address in the application / software is correct.



Successful Network Communication



Network Communication Failed

- If the network communication is failed, then check the communication between the link's ground unit and the air unit. If the communication is good, then check if the video cable between the camera and the link's air unit is good, and if the voltage input is in normal range.

4.7.2 Video Output to Windows Device

1. Use the “Win + R” key combo to wake up the “Run” program and input the command “cmd”.

```

C:\Windows\system32\cmd.exe
Microsoft Windows [版本 10.0.19042.804]
(c) 2020 Microsoft Corporation. 保留所有权利。

C:\Users\Administrator>ping 192.168.144

正在 Ping 192.168.0.144 具有 32 字节的数据:
Control-C
^C
C:\Users\Administrator>ping 192.168.144.25

正在 Ping 192.168.144.25 具有 32 字节的数据:
来自 192.168.144.25 的回复: 字节=32 时间=9ms TTL=64
来自 192.168.144.25 的回复: 字节=32 时间=3ms TTL=64
来自 192.168.144.25 的回复: 字节=32 时间=4ms TTL=64
来自 192.168.144.25 的回复: 字节=32 时间=3ms TTL=64
    
```

Successful Network Communication

```

C:\Windows\system32\cmd.exe

正在 Ping 192.168.144.25 具有 32 字节的数据:
Control-C
^C
C:\Users\Administrator>ping 192.168.144.25

正在 Ping 192.168.144.25 具有 32 字节的数据:
请求超时。
请求超时。
来自 192.168.144.153 的回复: 无法访问目标主机。
来自 192.168.144.153 的回复: 无法访问目标主机。

192.168.144.25 的 Ping 统计信息:
    数据包: 已发送 = 4, 已接收 = 2, 丢失 = 2 (50% 丢失),
C:\Users\Administrator>
    
```

Network Communication Failed

2. Input SIYI gimbal camera’s default IP addresses “192.168.144.25” and press the “Enter” key to check if the communication is successful. If it is, please check the RTSP addresses in the software or try to switch to another software.

3. If the network didn't connect, then check the communication between the link's ground unit and the air unit. If the communication is successful, then check if the video cable between the camera and the link's air unit is good, and if the voltage input is in normal range.

 **Mark**

If you have done all trouble shooting by following the steps above and still didn't solve the problem, then please contact your dealer, or contact SIYI Support directly.

4.8 Common IP Addresses

SIYI Optical Pod / Gimbal Camera's Default IP Addresses: 192.168.144.25

(OLD) SIYI Optical Pod / Gimbal Camera's Default RTSP Addresses:

rtsp://192.168.144.25:8554/main.264

(NEW) SIYI FPV App's Private Video Stream Protocol's Addresses:

- SIYI Camera 1 Main Stream: 192.168.144.25: 37256
- SIYI Camera 1 Sub Stream: 192.168.144.25: 37255
- SIYI Camera 2 Main Stream: 192.168.144.26: 37256
- SIYI Camera 2 Sub Stream: 192.168.144.26: 37255

 **Mark**

SIYI cameras released after ZT30 (including ZT30) start to use the new addresses.

SIYI cameras released before ZT30 still use the old addresses, including ZR30, A2 mini, A8 mini, ZR10, R1M Recording FPV Camera, etc.

5 SIYI FPV APP

SIYI FPV is an Android application developed by SIYI to configure many SIYI products for video display, camera stream settings, and communication link status monitoring.

Mark

This chapter is edited based on SIYI FPV App v2.5.12.572.

SIYI FPV App can be download from the relevant product pages on SIYI official website.

SIYI FPV App compatible SIYI devices.

- ZT30 Four-Sensor Optical Pod
- ZR30 4K AI 180X Hybrid Zoom Optical Pod
- A2 mini Ultra-Wide-Angle FPV Gimbal
- MK32 / MK32E Enterprise Handheld Ground Station
- A8 mini AI Zoom Gimbal Camera
- ZR10 2K 30X Hybrid Zoom Optical Pod

- R1M HD Recording FPV Camera
- Air Unit HDMI Input Converter
- HM30 Full HD Image Transmission System
- MK15 / MK15E Mini Handheld Ground Station

SIYI FPV App OSD Information Definition

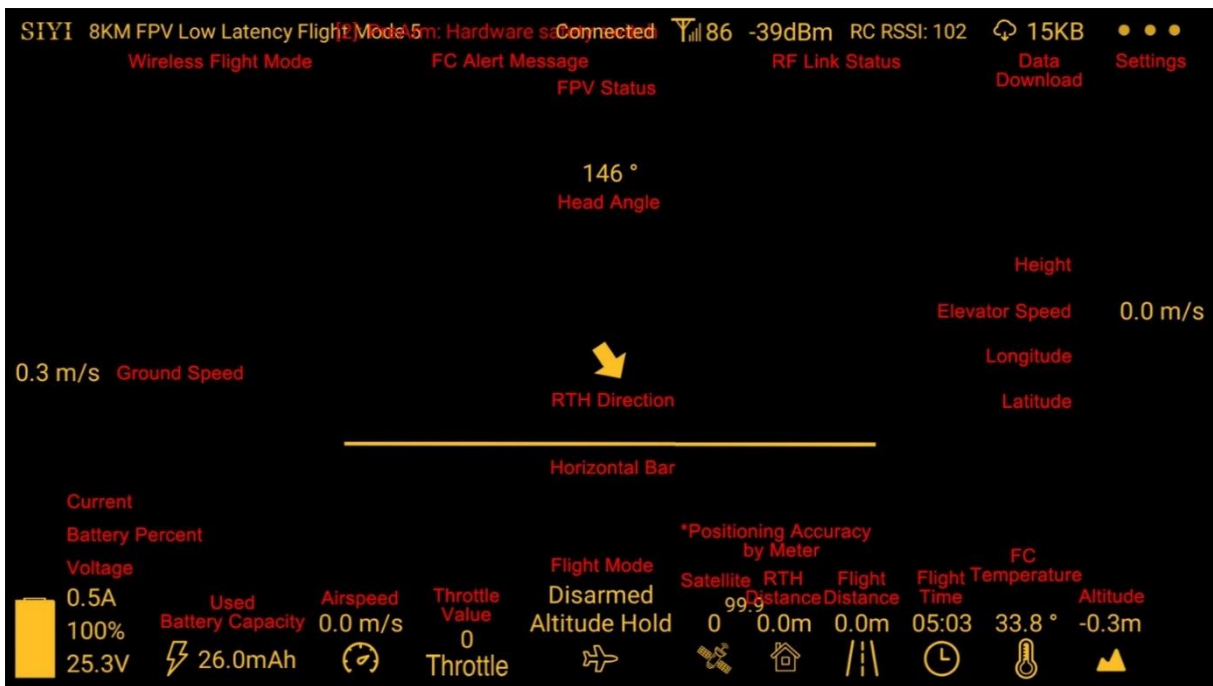

SIYI FPV Camera Function Icon Definition



5.1 Settings

In “Settings” page, you can select camera type with stream type, select or input video stream IP addresses, custom app interface, and switch video decoding type.

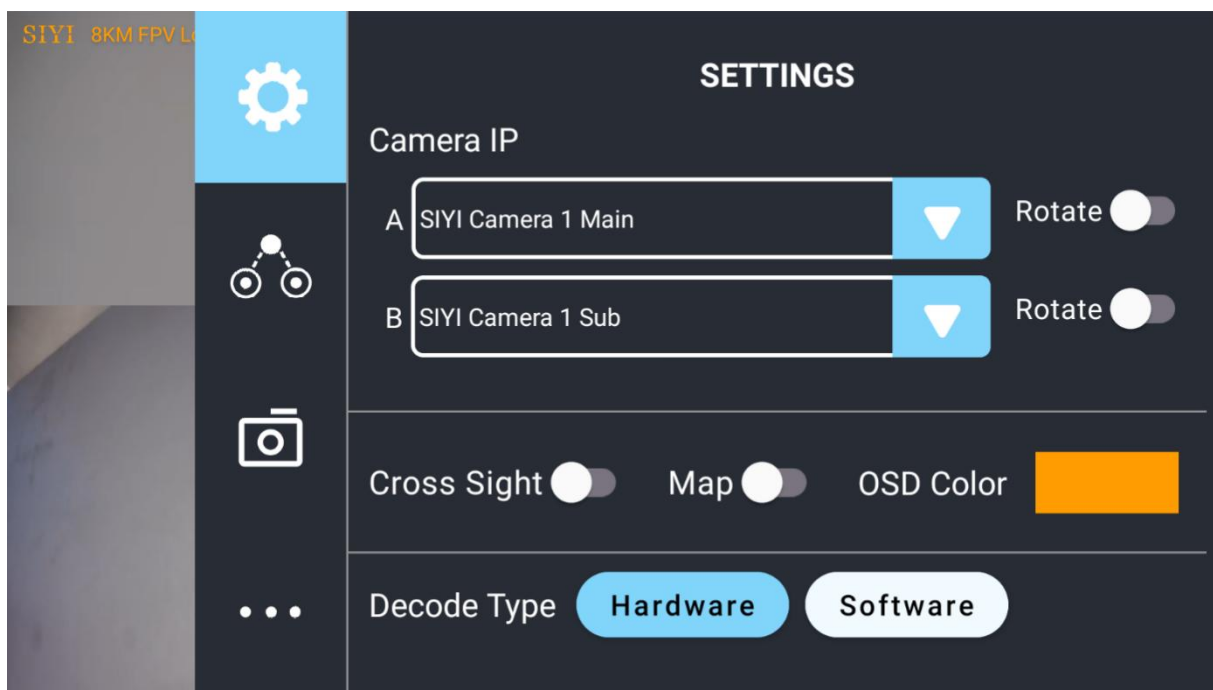

About Settings

Camera IP: Select between SIYI Camera 1 and SIYI Camera 2, between main stream and sub stream, select or input video stream RTSP addresses, disable image, or rotate the relevant image in 180 degrees.

Cross Sight: Enable / disable a cross sight in the center of the image.

Map: Enable / disable the map box over the left-bottom corner of the image.

OSD Color: Custom the color of all OSD information.

Decoding Type: Switch between “Hardware Decoding” and “Software Decoding”. Please refer to your camera and your device to display video for the best decoding type.

5.2 Link Status

Display the link status directly over the FPV image.

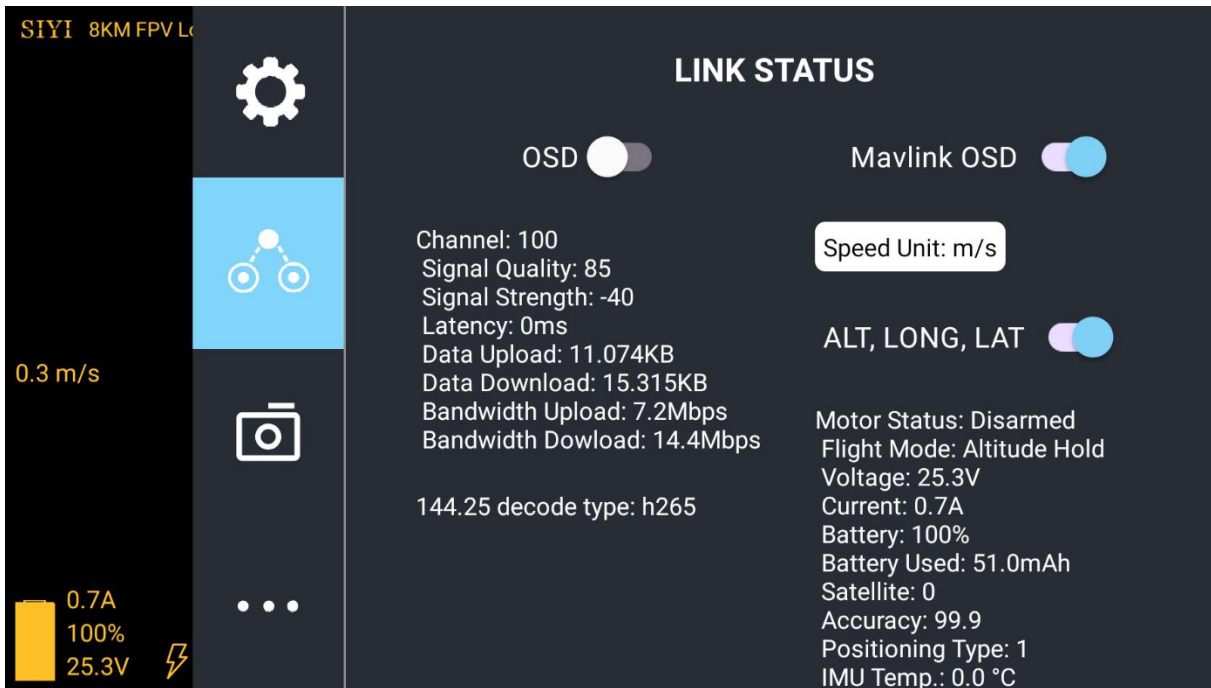

About Link Status

OSD: Enable / disable standard OSD information.

Mavlink OSD: Enable / disable Mavlink OSD information.

Speed Unit: Switch speed unit between meter per seconds and kilometer per hour.

Longitude and Latitude: Enable / disable information.

5.3 Gimbal Camera

Configure the basic functions for SIYI gimbal cameras and cameras.

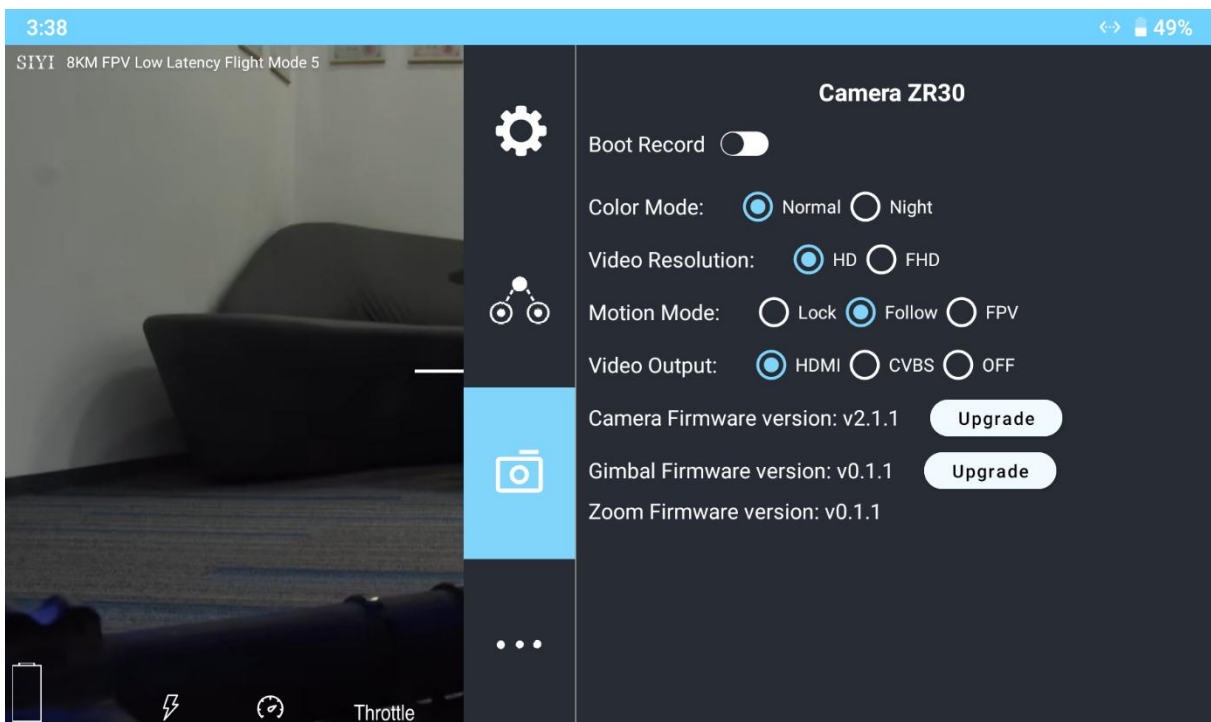

About Gimbal Camera

Auto Record: Turn on / off automatically video recording by TF card on gimbal camera start.

Record Resolution: Switch camera record resolution between HD (720p), Full HD (1080p), 2K, and 4K.

Gimbal Working Mode: Switch gimbal working mode among Lock Mode, Follow Mode, and FPV Mode.

- **Lock Mode:** Horizontally, gimbal does not follow when aircraft rotates.
- **Follow Mode:** Horizontally, gimbal follows when aircraft rotates.
- **FPV Mode:** Gimbal rotates simultaneously as aircraft rolls to get FPV view, and output enhanced stable images.

Camera Firmware Version: Display current camera firmware version.

Gimbal Firmware Version: Display current gimbal firmware version.

Zoom Firmware Version: Display current gimbal firmware version.

5.4 About SIYI FPV

Displays the software version of SIYI FPV and common contact information of SIYI Technology.

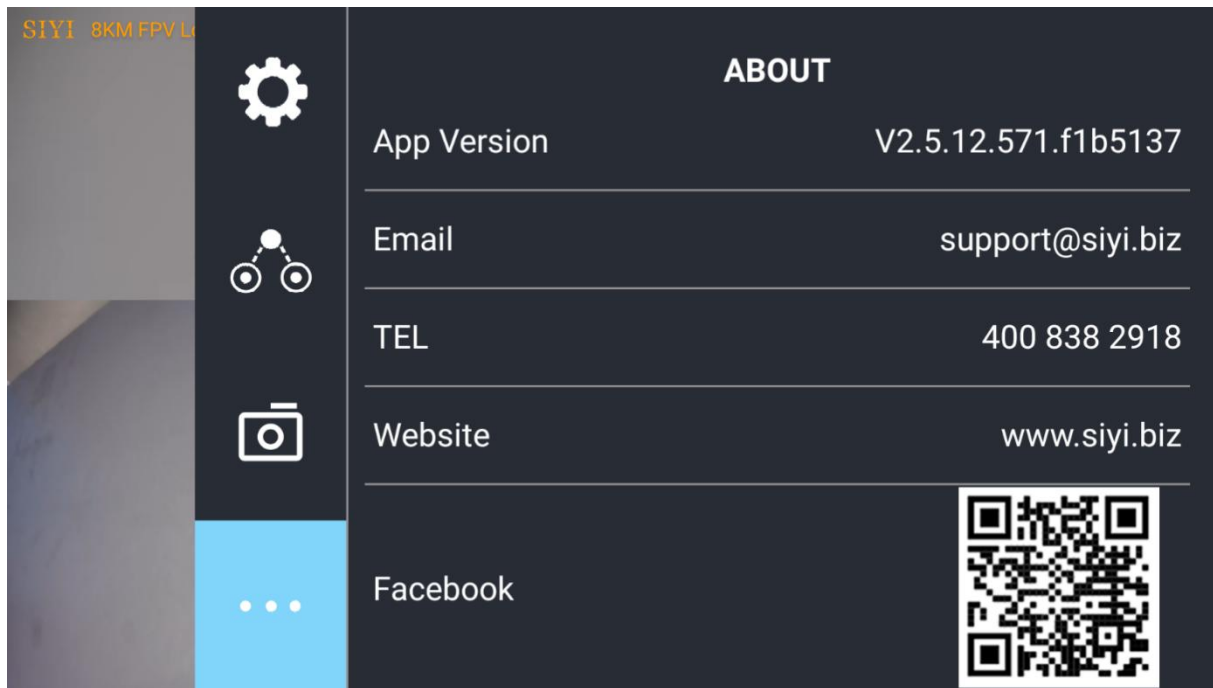

6 Firmware Upgrade and Configuration

SIYI PC Assistant is a Windows software developed by SIYI to configure many SIYI products for configuration, firmware update, and calibration.

Mark

The manual is edited based on SIYI PC Assistant v1.3.4.

6.1 Gimbal / Zoom Firmware Update

SIYI gimbal camera connects to SIYI PC Assistant for gimbal firmware and zoom firmware update.

Mark

Zoom firmware update is only available for zoom gimbal cameras only.

Before upgrading, it is necessary to prepare the tools, software, and firmware below.

- SIYI PC Assistant (v1.3.4 or latest version)
- Gimbal Firmware
- Zoom Firmware

Mark

Above software and firmware can be downloaded from relevant product page on SIYI official website.

- Cable (USB-C to USB-A)

Mark

Customers should prepare the above tools.

Firmware Upgrade Steps

1. Install “SIYI PC Assistant” on your Windows device.
2. Use the USB-C to USB-A cable to connect Windows device’s USB-A port to gimbal camera’s USB-C port.
3. Run “SIYI PC Assistant” and switch to “Upload” page to check gimbal camera’s current firmware version.

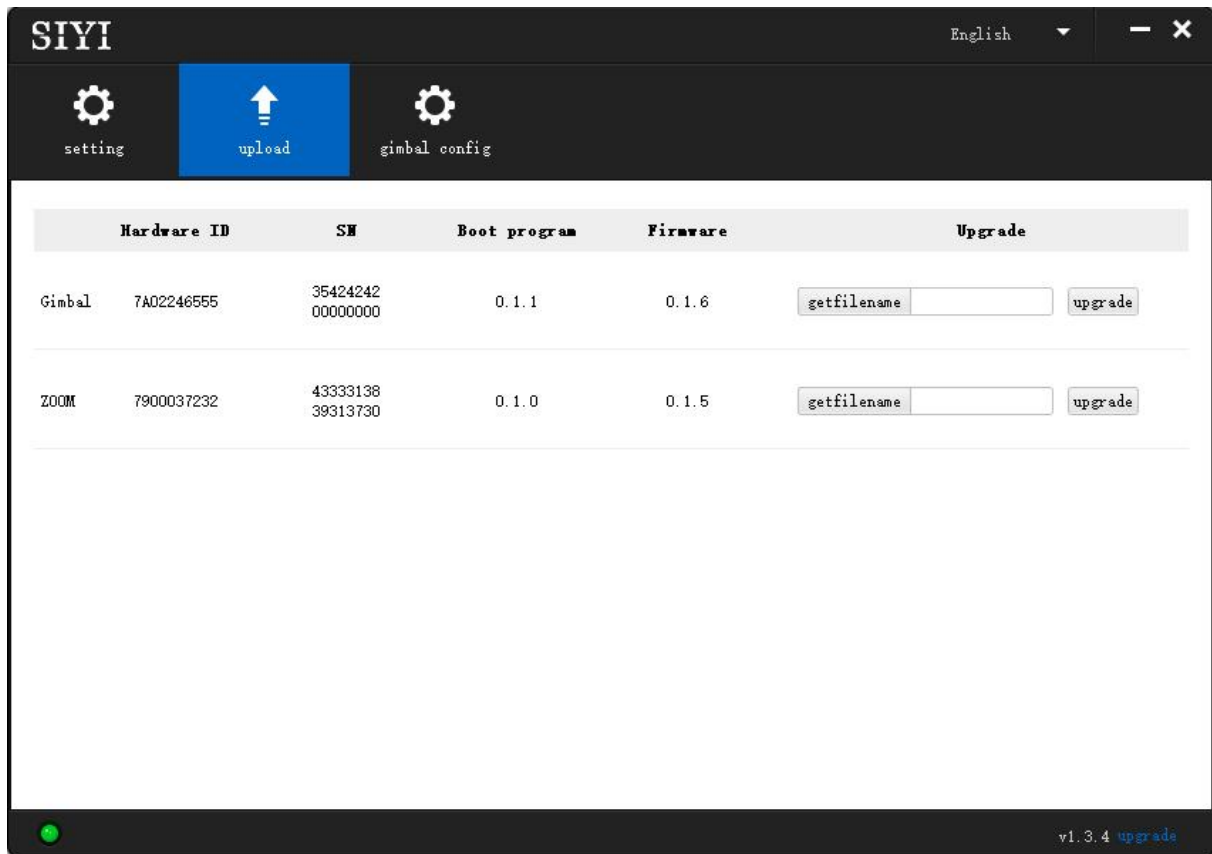

4. If the firmware is not latest, then click the “Select File” button in the “Gimbal” to import the latest firmware. And click “Upgrade” and wait till it is “100%” finished.

Mark

Before updating any firmware, gimbal camera should be powered.

It is the same process for both gimbal firmware and zoom firmware.

6.2 Camera Firmware Update

The camera firmware of SIYI gimbal camera should be upgraded by SD card.

Before upgrading, it is necessary to prepare the tools, software, and firmware below.

- Micro-SD Card (Class10, FAT32)

Mark

Customers should prepare the above tools.

- Camera Firmware

Mark

Above software and firmware can be downloaded from relevant product page on SIYI official website.

Firmware Upgrade Steps

1. Save camera firmware's ".bin" file to the SD card's root directory and do not change the file name.



名称	修改日期	类型	大小
SIYI_4K_MINI_UpgradeSD.bin	2022/10/28 18:22	BIN 文件	14,361 KB

2. Restart gimbal camera and wait for 3 to 5 minutes. Camera firmware will be flashed automatically.
3. Run SIYI FPV app or SIYI PC Assistant software to check if camera firmware is updated successfully.

6.3 Gimbal Camera Configuration

SIYI gimbal camera can be connected to SIYI PC Assistant for channel settings and camera settings.

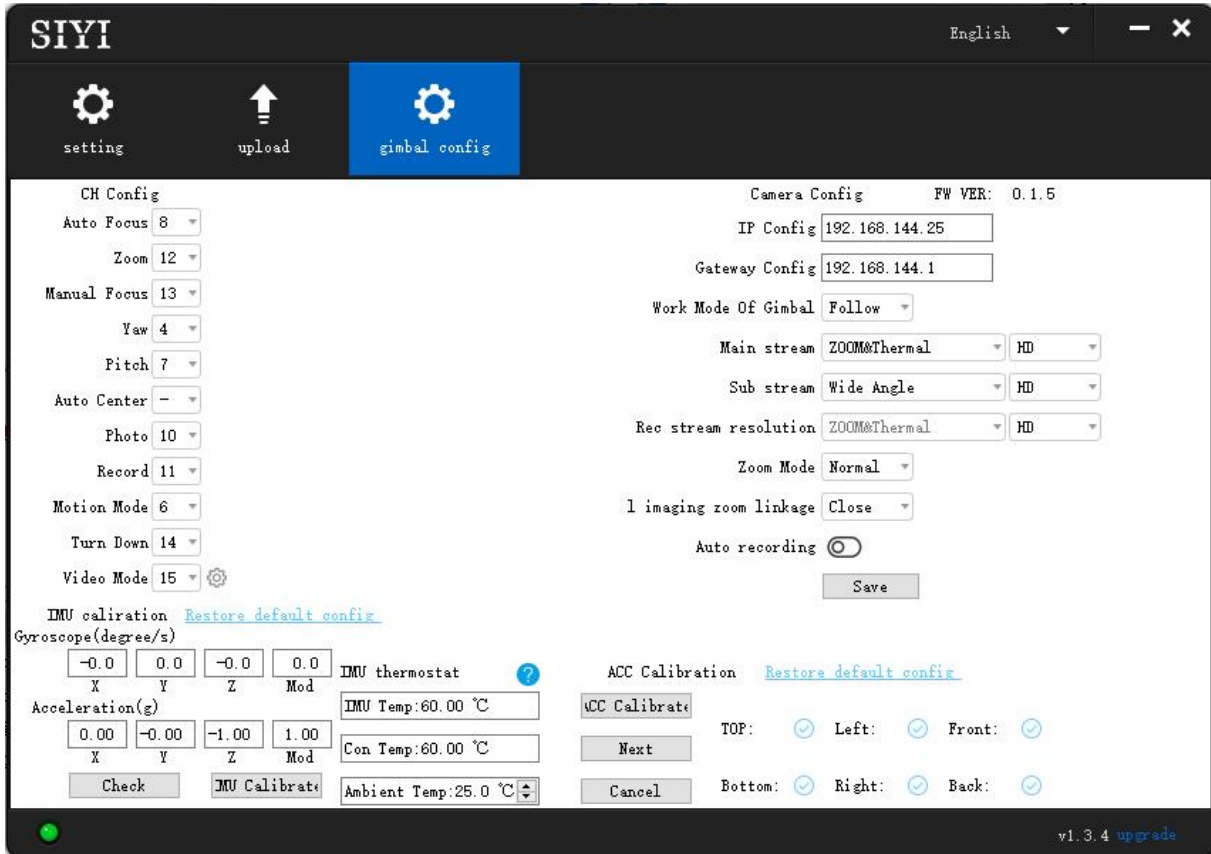

6.3.1 Channel Configuration

The “Channel Config” menu under “Gimbal Config” menu can assign the below gimbal camera functions to up to 16 channels and an idle channel (disabled).

Gimbal Functions and Description

- Auto Focus: Control zoom camera for automatic focus.

- Zoom: Control camera for optical zoom and digital zoom.
- Manual Focus: Adjust zoom camera focal length for manual focus.
- Yaw: Control gimbal rotation on yaw axis.
- Pitch: Control gimbal rotation on pitch axis.
- Auto Center: Control gimbal to reset to initial position. Coordinates (0, 0).
- Photo: Control camera to take a picture.
- Record: Enable / disable video recording.
- Motion Mode: Switch gimbal working mode (follow mode, lock mode, FPV mode).
- Auto Down: Control gimbal pitch axis to point downward vertically. Coordinates (0, -90).
- Image Mode: Select the video stream's image type and camera source. Single image or split image. Zoom camera, wide angle camera, or thermal imaging camera. Max three switches to be assigned for different image mode (for ZT30 only).

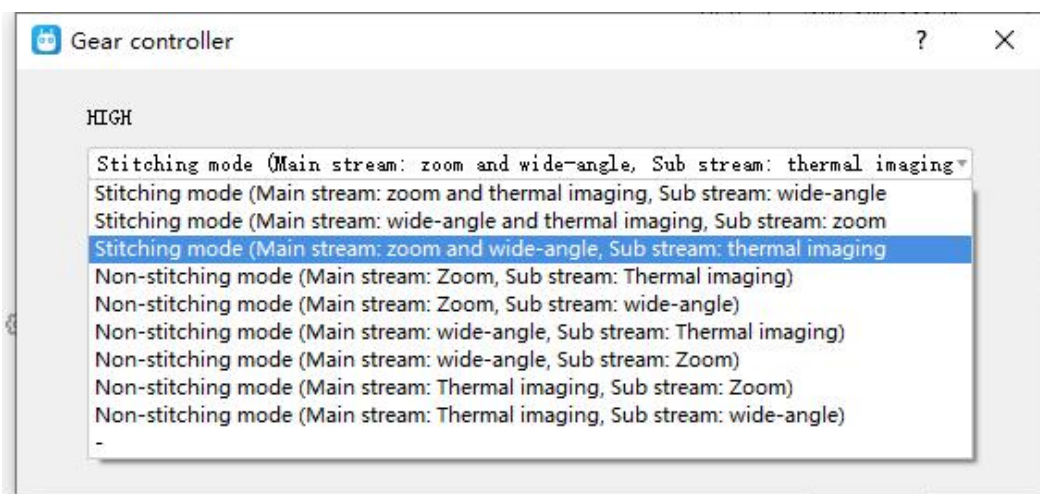
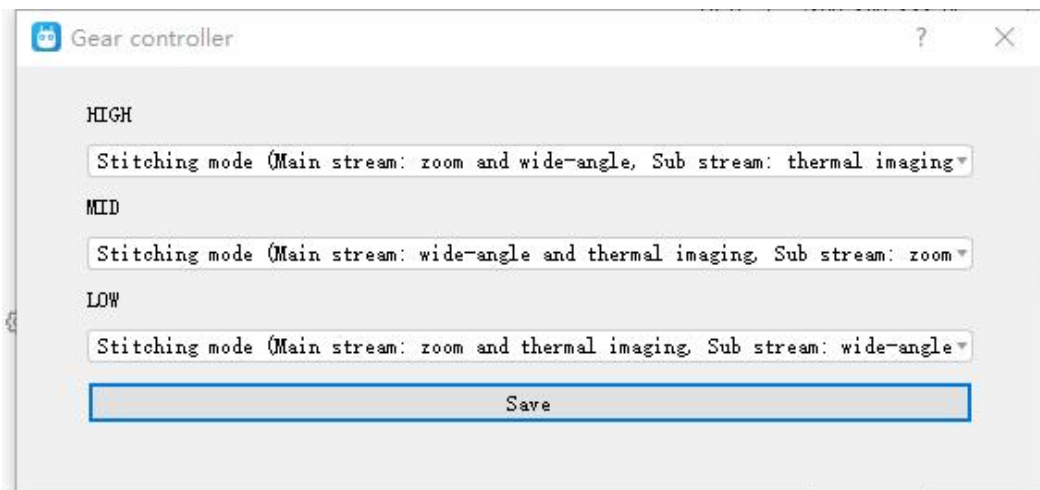

6.3.2 Camera Configuration

The “Gimbal Config” menu also supports abundant and core features of SIYI gimbal camera, such as, checking camera firmware version, modifying camera IP addresses, selecting camera source for main / sub stream and video recording, switching camera resolution or zoom mode, enabling / disabling thermal camera’s synchronized zoom, enabling / disabling boot recording.

About Camera Configuration

- IP Config: Modify camera IP addresses.
- Gateway Config: Modify camera gateway.
- Gimbal Working Mode: Switch gimbal working mode (follow mode, lock mode, FPV mode)
- Main Stream: Select camera source and switch output resolution for the main stream.
- Sub Stream: Select camera source and switch output resolution for the sub stream.
- Record Resolution: Select camera source and switch video resolution for recording.
- Zoom Mode: Switch zoom camera’s zoom mode (normal, absolute zoom).
- Boot Record: Enable / disable automatic video recording by TF card as soon as gimbal camera is powered.

6.3.3 Gimbal Calibration

The “Gimbal Calibration” can help users do IMU calibration, IMU Constant temperature calibration, and accelerator hexahedral calibration.

IMU Calibration

IMU calibration can keep the inertial measuring unit's accuracy and reliability.

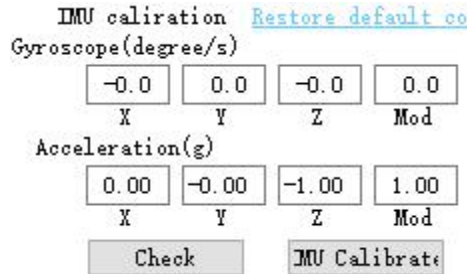

Steps

1. Click "Check", gimbal camera will power off automatically. Meanwhile, please follow the message box and place the gimbal camera on a flat surface and make sure that the IMU is static. Do not touch or vibrate the gimbal camera. Then go for "Start Checking".

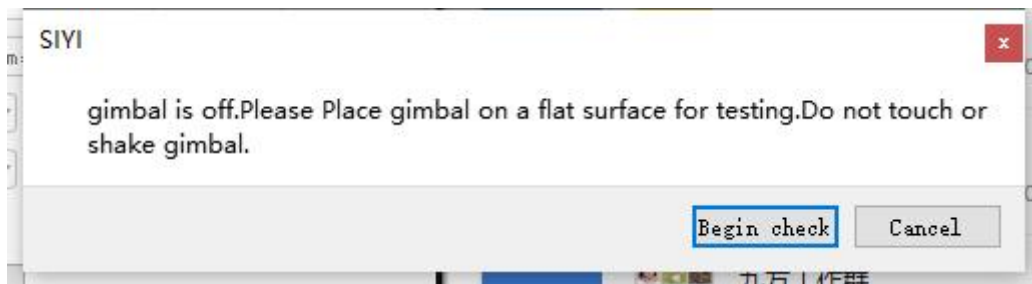

2. The PC assistant start to check IMU status automatically to determine if the gimbal should be calibrated.

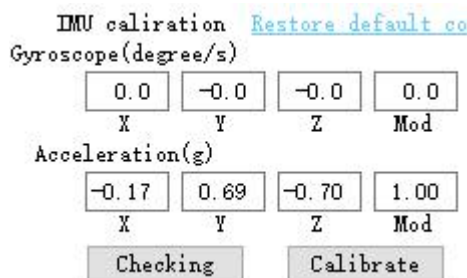

- If IMU is working normally, there will be a message box to indicate “not necessary to calibrate”.
- If IMU is not working normally, there will be a message box to indicate “calibration is necessary”.

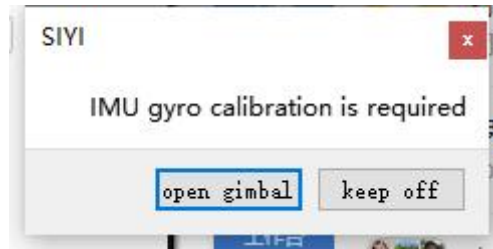

- Click “Start Gimbal” and “Calibrate”.
- The message box will say again “please follow the message box and place the gimbal camera on a flat surface and make sure that the IMU is static. Do not touch or vibrate the gimbal camera”.

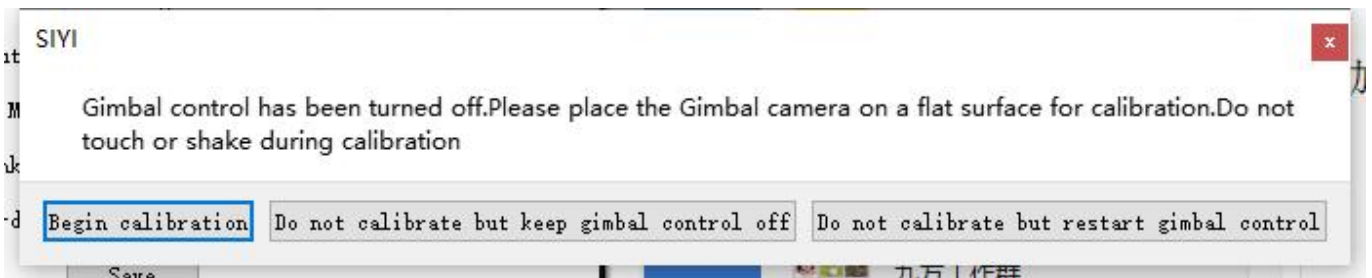

- IMU calibration menu will display “calibrating”.

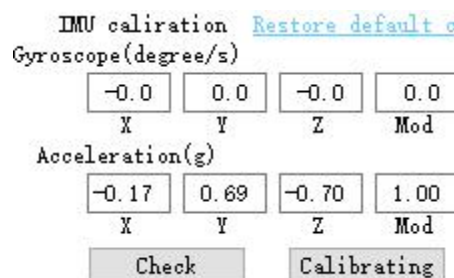

8. After a few seconds, IMU calibration will be finished.

IMU Constant Temperature Calibration

Specially designed for using gimbals in scenarios with big difference in temperature to avoid the situation that gimbal behaves abnormally because IMU cannot reach constant temperature normally and fast when the environment temperature is far from IMU constant temperature.

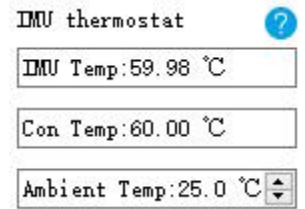

Before calibration, please input the environment temperature of your operating field, the software will start to calculate the target IMU constant temperature so that IMU can reach the temperature fast after powering on gimbal camera. The software is showing IMU temperature in real-time.

Accelerator Hexahedral Calibration

Accelerator hexahedral calibration can calibrate the accelerator's sensitivity, zero bias, and inter axis error, etc. During calibration, the gimbal should be placed in all hexahedrons to record accelerator's output value on each orientation and build the

error model. Hexahedral calibration can keep the accelerator's accuracy and reliability.

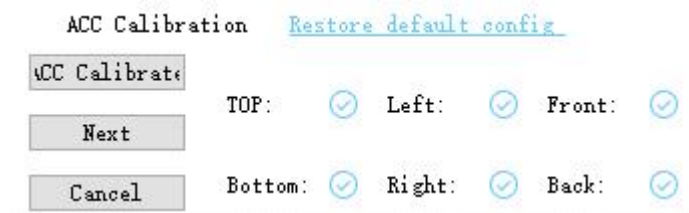

7 After-sale Service

If there were any questions or problems using SIYI Technology's product, you can always try to send an email to SIYI Official A/S Center (support@siyi.biz) or consult your sales representative or dealer for answers or solutions.

7.1 Repair Service

If your purchased SIYI products cannot work properly, please contact SIYI Official A/S Center for consulting.

Usually there are two situations for acquiring repair service.

- Product Defect
- Product Damage

SIYI products under the two situations can be sent back to SIYI for repairing. Defect products with valid warranty can be repaired for free. Defect products without valid warranty or damaged products should be charged of repair fees after repairing. Please refer to SIYI's Official A/S Quotation for detail.

7.2 Warranty

SIYI Technology guarantees that, subject to the following conditions, Return & Refund Service, Replacement Service, and Warranty Repair Service can be requested. Please contact SIYI directly (support@siyi.biz or your sales manager) or authorized SIYI dealer for more detail.

7.2.1 7-Day Return & Refund

You can request Return & Refund Service:

Within seven (7) days of receiving a product if the product has no manufacturing defect, has not been activated and is still in new or like-new condition.

Within seven (7) days of receiving a product if the product has a manufacturing defect.

Return & Refund Service will not be provided where:

It is requested beyond seven (7) calendar days of receiving a product.

A product sent to SIYI for Return & Refund Service does not include all original accessories, attachments or packaging, or any item is not in new or like-new condition, i.e., with cracks, dents, or scratches.

A legal proof of purchase, receipt or invoice is not provided or is reasonably believed to have been forged or tampered with.

Any fault or damage of the product is caused by unauthorized use or modification of the product, including exposure to moisture, entry of foreign bodies (water, oil, sand, etc.) or improper installation or operation.

Product labels, serial numbers, waterproof marks, etc. show signs of tampering or alteration.

Damage is caused to the product by uncontrollable external factors, including fire, floods, high winds, or lightning strikes.

A product is not delivered to SIYI within seven (7) calendar days after Return & Refund Service confirmation is sent from SIYI.

Other circumstances stated in this policy.

7.2.2 15-Day Replacement

You can request Replacement Service:

Within fifteen (15) calendar days of receiving the product if the product has sustained a substantial damage in transit, provided always that the damage proof issued by the carrier can be provided to SIYI.

Within fifteen (15) calendar days of receiving the product if the product does not match the original description of the product in one or more significant respects.

Within fifteen (15) calendar days of receiving the product if the product suffers performance failure.

Replacement Service will not be provided where:

Service is requested more than fifteen (15) calendars days after receiving a product.

Legal proof-of-purchase, receipts, or invoices are not provided, or are reasonably believed to have been forged or tampered with.

A product sent to SIYI for replacement does not include all original accessories, attachments, and packaging, or contains items damaged by user error.

A product is found to have no defects after all appropriate tests are conducted by SIYI.

Any fault or damage of the product is caused by unauthorized use or modification of the product, including exposure to moisture, entry of foreign bodies (water, oil, sand, etc.) or improper installation or operation.

Damage is caused by uncontrollable external factors, including fires, floods, high winds, or lightning strikes.

Received product has not been sent back to SIYI seven (7) calendar days after replacement confirmation from SIYI.

Proof of damage during transit issued by the carrier cannot be provided.

Other circumstances stated in this policy.

7.2.3 1-Year Warranty Repair

You can request warranty repair service:

If a product does not function as warranted during the warranty period, you may obtain after-sales service by contacting SIYI's service center. You will need to provide a valid proof-of-purchase, receipt, or order number for the warranty service.

Charges may apply for services not covered by this Limited Warranty. Please contact SIYI for information specific to your location.

Please note that the warranty service is only available in the respective SIYI service regions where you purchased your SIYI product.

Warranty Repair service will not be provided where:

Crashes or fire damage caused by non-manufacturing factors, including but not limited to pilot errors.

Damage caused by unauthorized modification, disassembly, or shell opening not in accordance with official instructions or manuals.

Damage caused by improper installation, in correct use, or operation not in accordance with official instructions or manuals.

Damage caused by non-authorized service provider.

Damage caused by unauthorized modification of circuits and mismatch or misuse of the battery and charger.

Damage caused by operation in bad weather (i.e., strong winds, rain, sand/dust storms, etc.)

Damage caused by operating the product in an environment with electromagnetic interference (i.e., in mining areas or close to radio transmission towers, high-voltage wires, substations, etc.)

Damage caused by operating the product in an environment suffering from interference from other wireless devices (i.e., transmitter, video-downlink, Wi-Fi signals, etc.)

Damage caused by reliability or compatibility issues when using unauthorized third-party parts.

Damage caused by operating the unit with a low-charged or defective battery.

Products or parts with an altered identification label or from which the identification label has been removed.

SIYI Technology (Shenzhen) Co., Ltd

Business Inquiry: info@siyi.biz

Phone: +86 400 838 2918

A/S Center: support@siyi.biz