

## MA40S4S/MA40S4R

### Ultrasonic Sensor Open Structure Type



#### Features

- High S.P.L. and high sensitivity
- Compact size(10.0mm dia.)
- Open type structure  
(indoor applications)

#### Applications

- Object detection
- Measuring the distance
- Dynamic body detection

#### Overview

MA40S4S / MA40S4R are ultrasonic transducer for various detections. MA40S4S is used to transmit ultrasonic waves. MA40S4R is used to receive them.

MA40S4S / MA40S4R consist of piezoelectric ceramics, metal plate, resonator and resin case. Resonator has like a funnel shape to transmit ultrasonic waves which is generated by vibration of resonator to the air efficiently(or to concentrate ultrasonic waves from the air on the center of resonance).Sound pressure level(S.P.L.) is the most important characteristic for ultrasonic transducers. For example, in measuring distance application, high S.P.L. transducer enables to detect the further distance.

MA40S4S / MA40S4R cannot be used in outdoor applications because they are open type structure. And they cannot be used for automotive applications. We can support only for consumer applications.

---

#### Attention:

This datasheet is downloaded from the website of Murata Manufacturing Co., Ltd. Therefore, it's specifications are subject to change or our products in it may be discontinued without advance notice. Please check with our sales representatives or product engineers before ordering.

## TABLE OF CONTENT

<b>1. Introduction</b> .....	<b>1</b>
<b>2. Specifications</b> .....	<b>3</b>
2.1 Absolute Maximum Ratings	
2.2 Performance of Electrical Specifications	
2.3 Environmental Tests	
<b>3. Measurement Direction</b> .....	<b>6</b>
3.1 Technical Performance Characteristic	
3.2 Murata Standard Measuring	
<b>4. Dimensions</b> .....	<b>8</b>
<b>5. ⚠CAUTION</b> .....	<b>9</b>
5.1 Limitation of Applications	
5.2 Fail-Safe	
5.3 Notice in design and usage	
5.4 Notice in storage	
5.5 Notice in mounting	
5.6 Other	

---

**Attention:**

This datasheet is downloaded from the website of Murata Manufacturing Co., Ltd. Therefore, it's specifications are subject to change or our products in it may be discontinued without advance notice. Please check with our sales representatives or product engineers before ordering.

## 1. Introduction

This document contains essential technical information about the MA40S4S / MA40S4R, including specifications. This document should be used as a reference when designing in MA40S4S / MA40S4R component

## 2. Specifications

### 2.1 Absolute Maximum Ratings

Table.1 Absolute Maximum Ratings of MA40S4S

Parameter	Spec.	Note
Operating Temperature Range	-40 ~ +85 degC	
Storage Temperature Range	-40 ~ +85 degC	
Max. Input Voltage	20Vp-p	at 40kHz, Square continuous wave

Table.2 Absolute Maximum Ratings of MA40S4R

Parameter	Spec.	Note
Operating Temperature Range	-40 ~ +85 degC	
Storage Temperature Range	-40 ~ +85 degC	

### 2.2 Performance of Electrical Specifications

Table.3 Performance of Electrical Specification of MA40S4S

Parameter	Spec.	Note
Operating Frequency	40.0kHz	For reference
S.P.L. (Sound Pressure Level)	120 +/- 3 dB	at 40kHz, 10Vrms, Sine wave, 0dB = 20uPa, 30cm(per Fig.5)
Capacitance	2,550pF +/- 20%	at 1kHz
Insulation Resistance	More than 100 Mohm	at 50 V D.C.
Temperature Characteristics	Within +/- 3dB against initial value at 25degC	-40 to +85 degC

#### Attention:

This datasheet is downloaded from the website of Murata Manufacturing Co., Ltd. Therefore, it's specifications are subject to change or our products in it may be discontinued without advance notice. Please check with our sales representatives or product engineers before ordering.

Table.4 Performance of Electrical Specification of MA40S4R

Parameter	Spec.	Note
Operating Frequency	40.0kHz	For reference
Sensitivity	-63 +/- 3 dB	at 40kHz, Sine wave, 0dB = 10V / Pa, 30cm(per Fig.6)
Capacitance	2,550pF +/- 20%	at 1kHz
Insulation Resistance	More than 100 Mohm	at 50 V D.C.
Temperature Characteristics	Within +/- 3dB against initial value at 25degC	-40 to +85 degC

## 2.3 Environmental Test

### 2.3.1 Shock Test (common)

The variation of the S.P.L. (sensitivity) at 40 kHz is within +/-3 dB compared with initial stage at 25 degC after applied following test conditions.

Acceleration	:	sine, 100G, 6ms
Direction	:	3 directions
Shock time	:	3 times / direction

### 2.3.2 Vibration Test (common )

The variation of the S.P.L. (sensitivity) at 40 kHz is within +/-3 dB compared with initial stage at 25 degC after applied following test conditions

Vibration frequency	:	10 to 55Hz
Sweep Period	:	1 min
Amplitude	:	1.5 mm
Direction	:	3 directions
Time	:	2 hours / direction

### 2.3.3 Resistance to Soldering Heat (common)

The variation of the S.P.L. (sensitivity) at 40 kHz is within +/-3 dB compared with Initial stage at 25 degC in 1hour after touching soldering iron (Iron temperature : 350 degC), 3 seconds with the terminal.(Touching point must be 2mm or more away from the sensor body.)

#### High Temperature Test (common)

The variation of the S.P.L. (sensitivity) at 40 kHz is within +/-3 dB compared with initial stage at 25 degC in 24 hours after applied following test conditions.

Temperature	:	+85 +/- 2 degC
Time	:	100 hours

#### Attention:

This datasheet is downloaded from the website of Murata Manufacturing Co., Ltd. Therefore, it's specifications are subject to change or our products in it may be discontinued without advance notice. Please check with our sales representatives or product engineers before ordering.

#### 2.3.4 Low Temperature Test (common)

The variation of the S.P.L. (sensitivity) at 40 kHz is within +/-3 dB compared with initial stage at 25 degC in 24 hours after applied following test conditions.

Temperature	:	-40 +/- 2 degC
Time	:	100 hours

#### 2.3.5 Humidity Test (common)

The variation of the S.P.L. (sensitivity) at 40 kHz is within +/-3 dB compared with initial stage at 25 degC in 24 hours after applied following test conditions.

Temperature	:	+60 +/- 2 degC
Humidity	:	90 to 95 %R.H.
Time	:	100 hours

#### 2.3.6 Operating Test (only MA40S4S)

The variation of the S.P.L. at 40 kHz is within +/-3 dB compared with initial stage at 25 degC in 24 hours after applied following test conditions.

Input Voltage	:	24Vp-p Square wave, 40kHz Continuous signal
Time	:	1000 hour

#### 2.3.7 Pull Strength (common)

There should be no substantial damage until 9.8N pulling force.

---

**Attention:**

This datasheet is downloaded from the website of Murata Manufacturing Co., Ltd.  
Therefore, it's specifications are subject to change or our products in it may be discontinued without advance notice.  
Please check with our sales representatives or product engineers before ordering.

### 3. Measurement direction

#### 3.1 Technical Performance Characteristics

##### 3.1.1 Frequency response characteristic

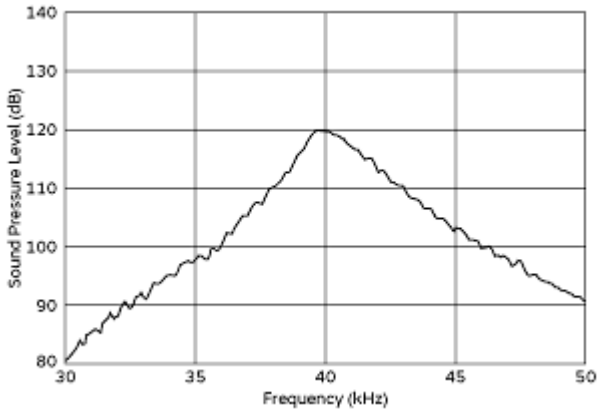

Fig.1 S.P.L.(MA40S4S)

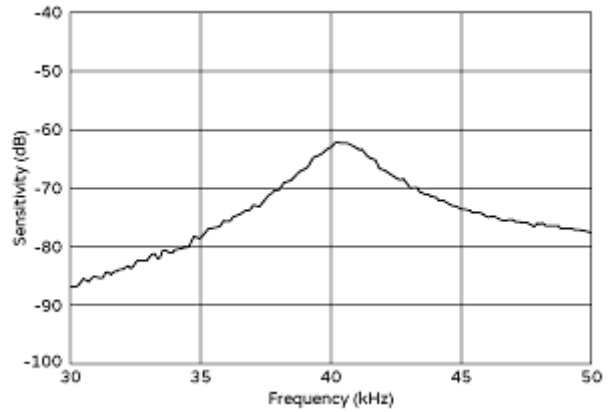

Fig.2 Sensitivity(MA40S4R)

##### 3.1.2 Directivity

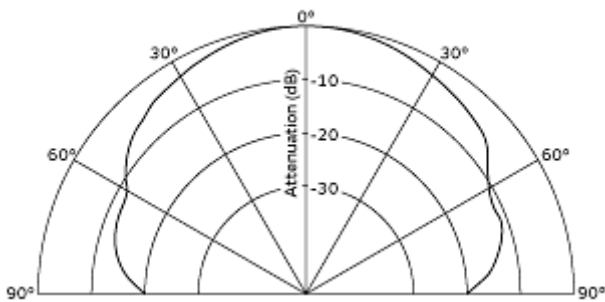

Fig.3 S.P.L.(MA40S4S)

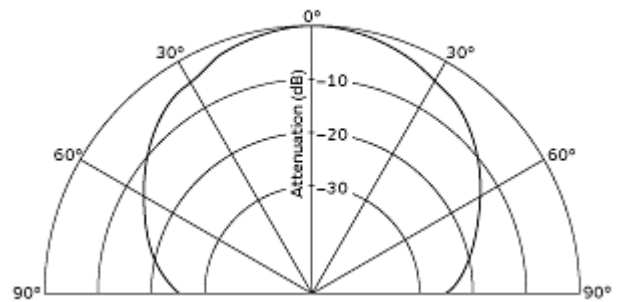
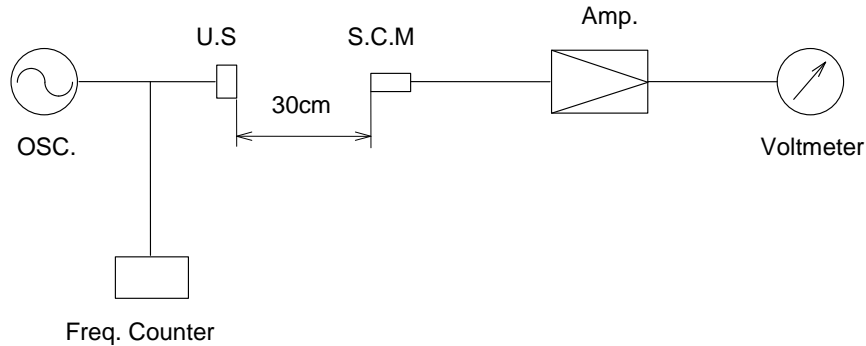

Fig.4 Sensitivity(MA40S4R)

#### Attention:

This datasheet is downloaded from the website of Murata Manufacturing Co., Ltd. Therefore, its specifications are subject to change or our products in it may be discontinued without advance notice. Please check with our sales representatives or product engineers before ordering.

### 3.2 Murata Standard Measuring



- OSC. : Oscillator (Brüel & Kjær 1013)
- U.S. : Ultrasonic Sensor
- S.C.M. : Standard Condenser Microphone (Brüel & Kjær 4135)
- Amp. : Amplifier (Brüel & Kjær 2610)

Fig.5 S.P.L. measuring system

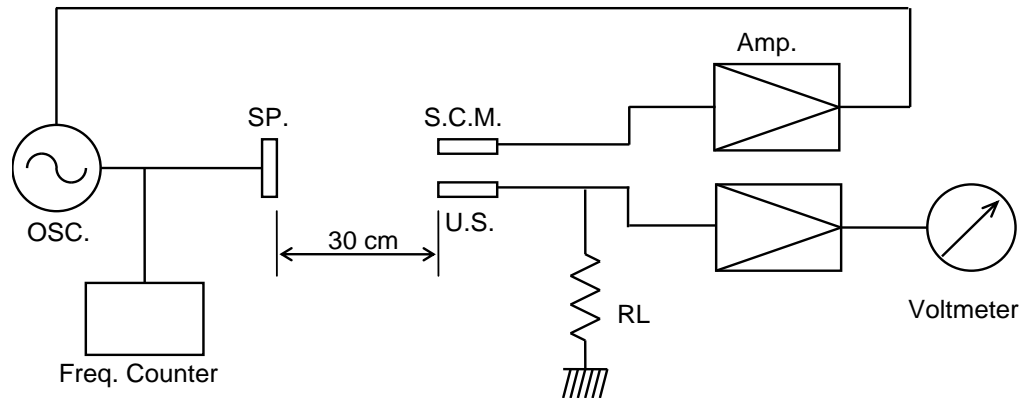

- OSC. : Oscillator (Brüel & Kjær 1013)
- U.S. : Ultrasonic Sensor
- S.C.M. : Standard Condenser Microphone (Brüel & Kjær 4135)
- Amp. : Amplifier (Brüel & Kjær 2610)
- SP. : Tweeter
- RL : 3.9 k ohm

Fig.6 Sensitivity measuring system

**Attention:**

This datasheet is downloaded from the website of Murata Manufacturing Co., Ltd. Therefore, it's specifications are subject to change or our products in it may be discontinued without advance notice. Please check with our sales representatives or product engineers before ordering.

## 4. Dimensions

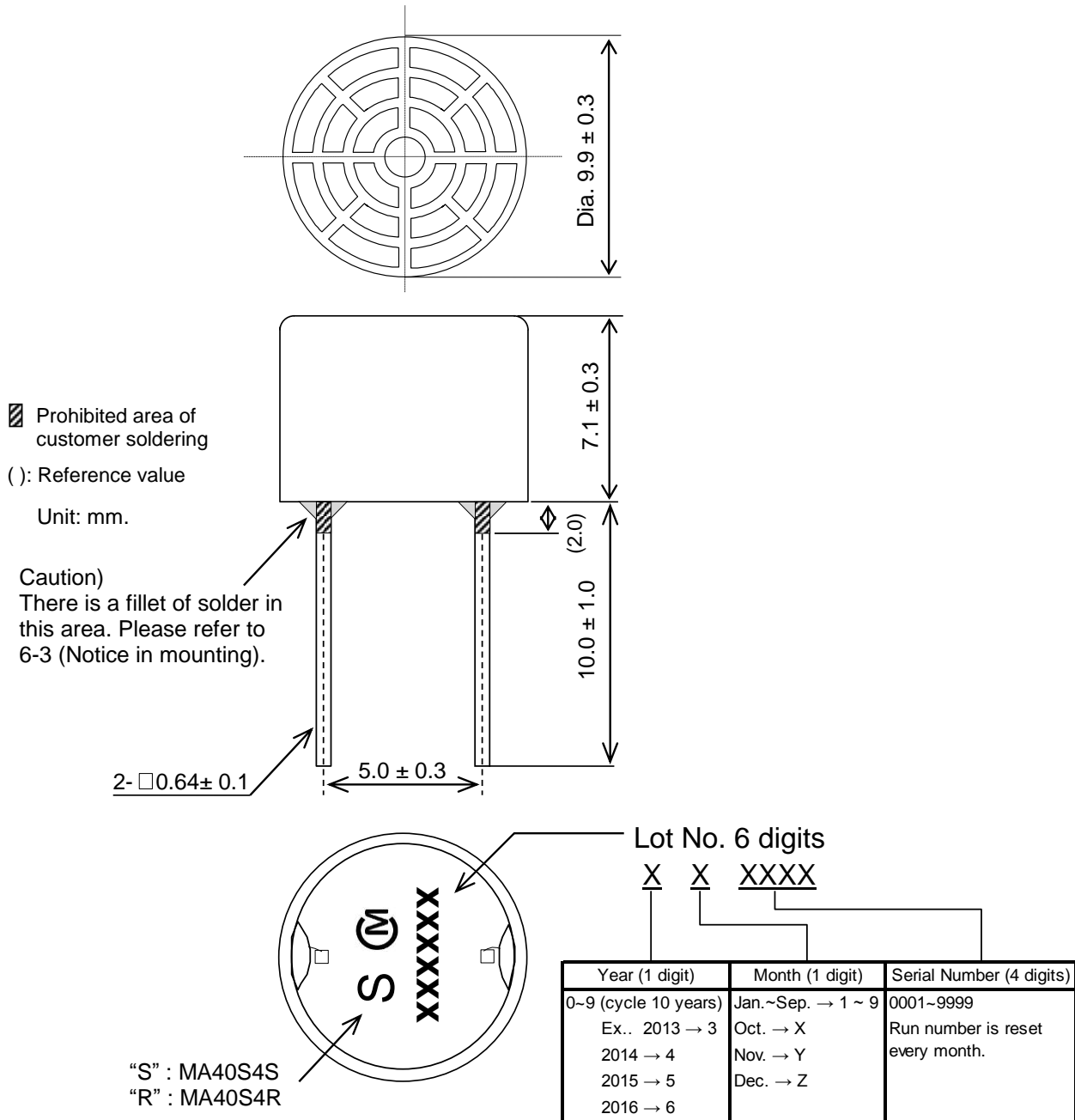

Fig.7 Product dimension

### Attention:

This datasheet is downloaded from the website of Murata Manufacturing Co., Ltd. Therefore, its specifications are subject to change or our products in it may be discontinued without advance notice. Please check with our sales representatives or product engineers before ordering.



## 5. ⚠Caution

### 5.1 Limitation of Applications

Please do not use in the applications listed below which require a high reliability to prevent the defects which might cause a damage to the Peoples' life and/or property.

- 1) Aircraft equipment
- 2) Aerospace equipment
- 3) Undersea equipment
- 4) Power plant control equipment
- 5) Medical equipment
- 6) Transportation equipment (trains, ships, etc.)
- 7) Traffic signal equipment
- 8) Disaster prevention / crime prevention equipment
- 9) Data-processing equipment
- 10) Military equipment (regardless of directly/indirectly)
- 11) Security device/system
- 12) Outside-usage, in which the sensor is exposed to splashes or dusts

Application of similar complexity and/or reliability requirement to the applications listed in the above

### 5.2 Fail-Safe

Please make sure to provide an appropriate fail-safe function on your product to prevent a second damage that may be caused by the abnormal function or the failure of our product

### 5.3 Notice in design and usage

- 1) The transducer may generate surge voltage by mechanical or thermal shock.
- 2) Please do not apply D.C. voltage for ultrasonic transducer to avoid migration.
- 3) Please do not use this ultrasonic sensor in water.
- 4) Please do not apply an excessive mechanical shock or force on the top of this ultrasonic transducer and terminal pins. It may cause of disconnection and malfunction.
- 5) Please do not use nor storage this ultrasonic sensor in heavy dust condition. It may be a cause of clogging and low performance. Also, please do not use this sensor in high humidity or high concentrated exhaust gas. It may be a cause of corrosion and malfunction.
- 6) Care should be taken when select the material to hold, or cover backside of transducer. If it contains sulfur or sulfide, electrode on piezo-electric element may be corroded and became malfunction.
- 7) This transducer does not have a definition of terminal polarity. Please check a signal before using if you need a signal phase control for your application.

---

#### Attention:

This datasheet is downloaded from the website of Murata Manufacturing Co., Ltd.  
Therefore, it's specifications are subject to change or our products in it may be discontinued without advance notice.  
Please check with our sales representatives or product engineers before ordering.

#### 5.4 Notice in storage

- 1) The products should not be used or stored in a corrosive atmosphere, especially where chloride gas, sulfide gas, acid, alkali, salt or the like are present. Store the products in the room where is normal temperature and humidity, and avoid the sunlight, sudden changes in temperature and humidity. It may cause of failure or malfunction in such conditions.
- 2) Store the products where the temperature and relative humidity do not exceed -10 to 40 degC, and 30 to 80 %RH. Use the products within 6 months after receiving contents.

#### 5.5 Notice in mounting

- 1) Please do not apply excessive force to terminals, when soldering.
- 2) Please use soldering temperature with not exceeds 350 degC, 3 seconds.
- 3) Flow soldering is not applicable.
- 4) Please do not clean by water and dissolving agent.

This product cannot be used mounted on PCB. Soldering fillet at the bottom of case may interfere with throughhole of PCB. Please contact products engineering section of Murata if you will use this product mounted on PCB

#### 5.6 Other

- 1) Please make sure that your product has been evaluated in view of your specifications with our product being mounted to your product.
- 2) You are requested not to use our product deviating from the agreed specifications.
- 3) We consider inappropriate to include any terms or conditions with regard to the business transaction in the product specifications, drawings or other technical documents. Therefore, if your technical documents as above include such terms and conditions such as warranty clause, product liability clause, or intellectual property infringement liability clause, they will be deemed to be invalid

---

#### Attention:

This datasheet is downloaded from the website of Murata Manufacturing Co., Ltd. Therefore, it's specifications are subject to change or our products in it may be discontinued without advance notice. Please check with our sales representatives or product engineers before ordering.