

Orange Li-ion BMS

3S 12V 20A

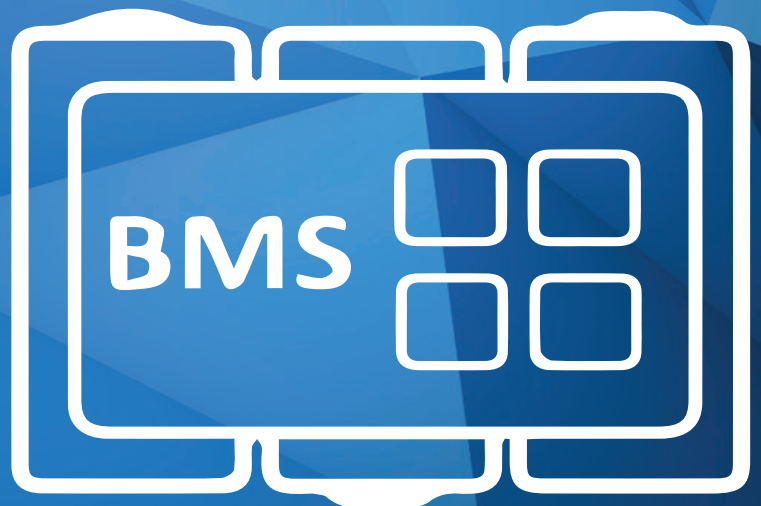

The major Primary Function of the Battery Management System (BMS)

It Protects the Battery pack from being over-charged (cell voltages going too high) or over-discharged (cell voltages going too low) thereby extending the life of the battery pack. It does this by constantly monitoring every cell in the battery pack and calculating exactly

how much current can safely go in (source, charge) and come out (load, discharge) of the battery pack without damaging it. These calculated current limits are then sent to the source (typically a battery charger) and load (motor controller, power inverter, etc), which are responsible for respecting these limits.

There are also secondary functions that the BMS performs:

1) Balances all the cells in the battery pack by intelligently bleeding off excess energy from cells that are charged more than others. This provides the maximum amount of usable energy (capacity) from the battery pack since the pack is only as strong as the weakest cell.

2) Monitors the temperature of the battery pack and controls a battery fan to regulate the temperature of the pack. Additionally, it constantly monitors the output of the fan to make sure it is working properly.

3) Provides real-time information and values to other devices such as motor controllers, chargers, displays and data loggers using several different methods (CANBUS, analog outputs, and digital outputs).

4) Stores error codes and comprehensive diagnostic information to aide in fixing problems with the battery pack should any issues arise.

03 Specification

Discharge

Continuous Discharge current: 20 A

Charge

Charge Voltage: 12.6 V

Charge Current: 10 A

Overcharge Protection

Overcharge Detect Voltage: 4.25 ± 0.05 V

Balance

Balance Detect Voltage: 4.18V

Balance current: 30 ± 5 mA

Over Discharge Protection

Over discharge detect: 2.7 ± 0.1 V

Over discharge release voltage: 3.0 ± 0.1 V

Charging over current protection

Charging overcurrent protection: 13 ± 2 A

Discharge overcurrent protection

Discharge overcurrent protection current: 60 ± 10 A

Inner resistance

Main Circuit Conduct Inner Resistance: < 20 m Ω

Working Temperature

Main Circuit Conduct Inner Resistance: $-20 \sim 70^{\circ}\text{C}$

Working Temperature

Main Circuit Conduct Inner Resistance: $-40 \sim 80^{\circ}\text{C}$

Wiring Connection:

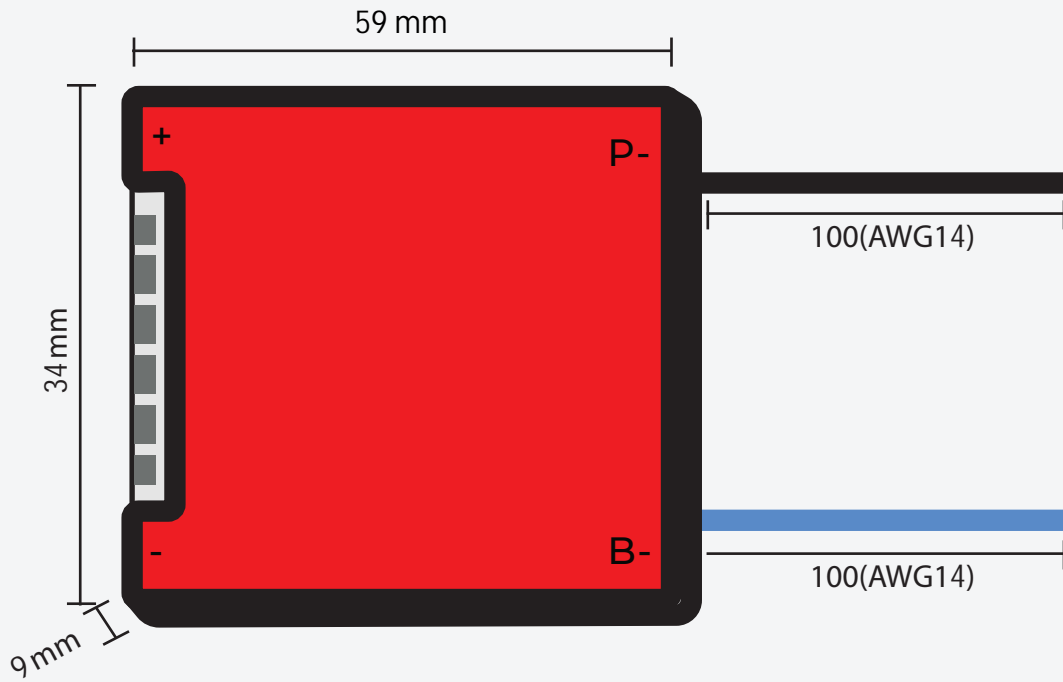

Wiring Diagram

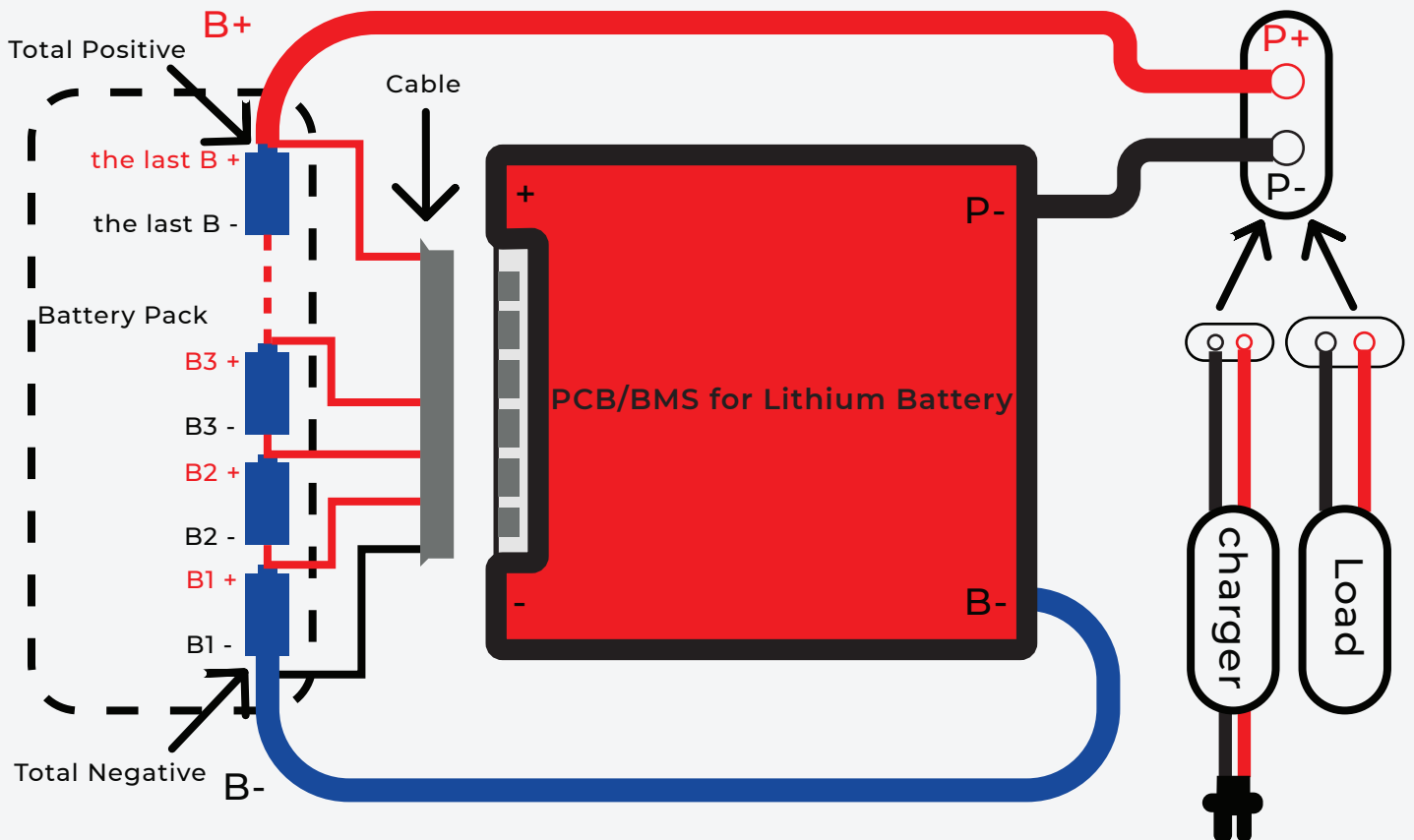

05 Wiring Operation

- 1) First connect the B-cable of the protection board to the total negative pole of the battery pack.
- 2) The cable starts from the thin black one connecting B-, the second red cable connects the positive pole of the first string of batteries, and the next string is connected in turn. The positive pole of the pool; then insert the cable into the protection board.
- 3) After finishing the wiring soldering, measure whether the battery B+, B-voltage and P+,P-voltage values are the same, only same, the protection board works positively. Otherwise. Please follow the above re-operation;
- 4) When removing the protection board, first pull out the cable (if there are two cables, pull the high-voltage cable first, then pull the low-voltage cable), then remove Power cable B-

Warranty

All our produced Lithium battery BMS, we guarantee 1 year's warranty in quality, except the damage caused due to Improper human Operation.

Attention

- 1) Lithium battery BMS with different voltage range which cannot be mixed using., LifePo4 BMS cannot be used for Li-ion battery.
- 3) When testing, installing, contacting, and using the protective board, take measures to put static electricity on it.
- 4) Mustn't let the heat dissipation surface of the protection board directly contact the battery core, otherwise the heat will be transmitted to the battery core, which will affect the safety of the battery.
- 5) Do not disassemble or change the components of the protection board by yourself.
- 6) The metal heat sink of the protection board of the company is anodized and insulated, and the oxide layer will still be conductive after being destroyed. Avoid contact between the heat sink and the battery core and the nickel strip
- 7) If the protection board is abnormal, please stop using it. Then use it again after it is checked with OK.
- 8) Do not use the two protective boards in series or in parallel.